

Guidelines for the Design and Placement of Transit Stops

December 2009

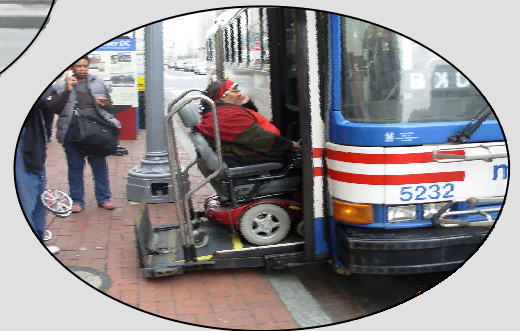

Washington Metropolitan Area Transit Authority

Guidelines for the Design and Placement of Transit Stops

Prepared by:

KFH Group, Inc.
4920 Elm Street
Suite 350
Bethesda, MD 20814
Phone (301)951-8660

Under Subcontract to:

P²D

Prepared for:

Washington Metropolitan Area Transit Authority



TABLE OF CONTENTS

Introduction 1

Bus Stop Placement, Spacing, and Type

Bus Stop Location..... 2
Bus Stop Spacing 5
On-Street Bus Stop 7
Curb Bulb..... 8
Bus Bays 8

Bus Stop Elements and Passenger Amenities

Bus Stop Hierarchy10
Bus Stop Sign10
Bus Stop Post..... 11
Information Case 11
Lighting 12
ADA Landing Pad13
Benches.....14
Passenger Shelters15
Trash Receptacles16
Vendor Boxes16
Shelter Maps 17

Bus Stop Prototypes

Basic Bus Stop.....18
Sheltered Bus Stop19

Introduction

The bus stop guidelines provided in this brochure are intended to provide Metro and its jurisdictional partners specific physical design criteria to be integrated with local comprehensive plan policies, land use ordinances, pedestrian plans, and street design guidelines. The design guidelines may also be used as a basis when working with local jurisdictions in planning access improvements to transit facilities. Developers or builders who are interested in developing transit friendly projects may also make use of these design guidelines.

This brochure is organized as follows:

Bus Stop Placement, Spacing, and Type

This section presents guidelines for improving bus passenger experience on the street side. Provided are guidelines for appropriate bus stop placement relative to the intersection, bus stop spacing and different types of street-side designs such as on-street stops, curb-bulbs, and bus bays.

Bus Stop Elements and Passenger Amenities

This section presents guidelines for improving the accessibility to bus stops and the coordination of bus stop elements such as bus stop signs, bus stop posts, information cases, customer information, bus stop shelters, benches, bus stop lighting, Americans with Disabilities Act (ADA) landing pads, trash receptacles, vendor boxes, and art at transit stops.

Bus Stop Prototypes

Stop design, layout, and configuration are determined by a variety of elements. Some of those elements are rights-of-way, pedestrian infrastructure, site constraints, land use, vehicle speed and volume, parking, pedestrian volume, and local policies. Provided in this section are examples of prototypical designs of bus stop facilities that are common for the Washington Metropolitan region.



BUS STOP PLACEMENT, SPACING, AND TYPE

Bus Stop Location

Description

The location of a bus stop generally refers to the placement of the stop relative to the nearest intersection. The three types of bus stop placement as it relates to the intersection are:

- Near-side (upstream) of the intersection
- Far-side (downstream) of the intersection
- Mid-block (midway between intersections)

Usage Factors

Far-side and near-side stops are preferred over mid-block stops as they can provide pedestrians greater access and safety when crossing the street. However, the best location will depend on vehicular and pedestrian patterns at the intersection, right-of-way availability, bus routing, roadway conditions, pedestrian facilities, and other conditions found at the site. It is important to note that bus stops are typically located in pairs (one on each side of the street along two-way route segments) and is generally recommended that bus stop pairs be positioned close together along the route to ensure simplicity in planning the return trip. The advantages and disadvantages for each type of bus stop location are provided in Table 1. In addition to the circumstances under which each location is recommended.

Bus stop locations near primary schools should be placed in an area where they can be visually monitored by school personnel and/or crossing guards to increase safety and security.

Other Location Factors

- Locate stops served by multiple routes to minimize or protect (by way of intersection signals) street crossings for passengers making transfers between routes.
- Avoid placement in proximity to driveways; where unavoidable:
 - ⇒ Attempt to keep at least one exit and entrance driveway open for vehicles to access the site
 - ⇒ Locate stop where visibility for vehicles leaving the site is not obstructed, minimizing vehicle / bus conflicts (i.e., far-side of the driveway)
 - ⇒ Locate stop so passengers do not wait, board, or alight in the driveway
 - ⇒ It is preferable for the bus to fully rather than partially block a driveway
- Locate bus stops where they are easy to see by the bus operator, as well as other drivers and bicyclists. To minimize the risks of a bus being struck from behind while stopped in the roadway at a bus stop or pulling back into traffic from an off-street stop, bus stops should not be placed:
 - ⇒ Immediately over a crest of a hill, or
 - ⇒ Immediately beyond a curve where traffic is curving right

Table 1. Bus Stop Locations

Location Related to Intersection	Advantages	Disadvantages	Where Recommended
Far-side	<ul style="list-style-type: none"> • Minimizes conflicts between right turning vehicles and buses • Provides additional right turn capacity by making curb lane available for traffic • Minimizes sight distance problems on approaches to intersection • Encourages pedestrians to cross behind the bus • Creates shorter deceleration distances for buses • Results in bus drivers taking advantage of gaps in traffic flow created at traffic signals 	<ul style="list-style-type: none"> • May result in intersections being blocked during peak periods by parked buses • May obscure sight distance for crossing vehicles • May increase sight distance problems for pedestrians • Can cause a bus to stop far-side after stopping for a red light • May increase number of rear-end accidents since drivers do not expect buses to stop again after a red light • Could result in traffic queued into intersection 	<ul style="list-style-type: none"> • There is a high volume of turns • Route alignment requires left turn • Complex intersections with multi-phase signals or dual turn lanes • Traffic is heavier on the near-side • Existing pedestrian conditions are better on far-side • Traffic conditions and signals may cause delays if near-side • Intersections have transit signal priority treatments
Near-side	<ul style="list-style-type: none"> • Minimizes interference when traffic is heavy on the far side of the intersection • Allows passengers to access buses closest to the crosswalk • Results in the width of the intersection being available for the driver to pull away from the curb • Allows passengers to board and alight while the bus is stopped at a red light • Provides driver with opportunity to look for oncoming traffic 	<ul style="list-style-type: none"> • Increases conflicts with right-turning vehicles • May result in stopped buses obscuring curbside traffic control devices and crossing pedestrians • May cause sight distance to be obscured for cross vehicles stopped to the right of the bus • May block the through lane during peak period with queuing buses • Increases sight distance problems for crossing pedestrians 	<ul style="list-style-type: none"> • Traffic is heavier on the far-side • Existing pedestrian conditions are better than on the far-side • Pedestrian movements are safer on near-side • Bus route continues straight through the intersection
Mid-block	<ul style="list-style-type: none"> • Minimizes sight distance problems for vehicles and pedestrians • May result in passenger waiting areas experiencing less pedestrian congestion 	<ul style="list-style-type: none"> • Requires additional distance for no-parking restrictions • Encourages jaywalking • Increase walking distance for patrons crossing intersections 	<ul style="list-style-type: none"> • When the route alignment requires a right turn and curb radius is short • Problematic traffic conditions at the intersection • Passenger traffic generator is located mid-block • Compatible with corridor or district plan

BUS STOP PLACEMENT, SPACING, AND TYPE

Design Factors

Far-Side Stops

Figure 1 provides the recommended dimensions of a typical far-side bus stop location. For a standard 40' transit bus, the bus stop should be located at least 50' after the intersection to ensure that the rear of the bus does not extend into the intersection and/or straddles the pedestrian crosswalk. Far-side bus stop locations should be used if:

- The near-side of the intersection is a right turn lane
- The primary trip generator is upstream from the intersection
- Existing pedestrian facilities are greater than on the near-side
- There is a high volume of right turns near-side of the intersection
- The intersection is a complex intersection with multi-phase signals or dual turn lanes
- The stop is part of a Bus Rapid Transit (BRT) service
- Pedestrian movements are safer than on the near-side
- Vehicular traffic is heavier on the near-side of the intersection

Figure 1. Far-Side Bus Stop Location

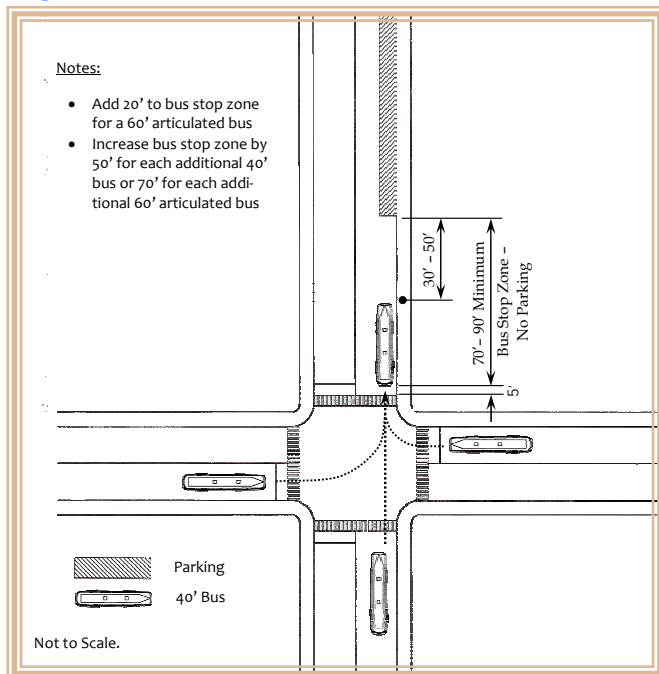

Near-Side Stops

Figure 2 provides a diagram with the recommended dimensions for a typical near-side bus stop. Bus stops located near-side of the intersection should be placed at least 5' from the crosswalk to prevent the bus from straddling the crosswalk while it is stopped to serve the stop. Near-side bus stop should be utilized if:

- The primary trip generator is downstream from the intersection
- Existing pedestrian facilities are greater than on the far-side
- Pedestrian movements are safer than on the far-side
- Route requires a right turn at the intersection.
- Vehicular traffic is heavier on the far-side

Figure 2. Near-Side Bus Stop Location

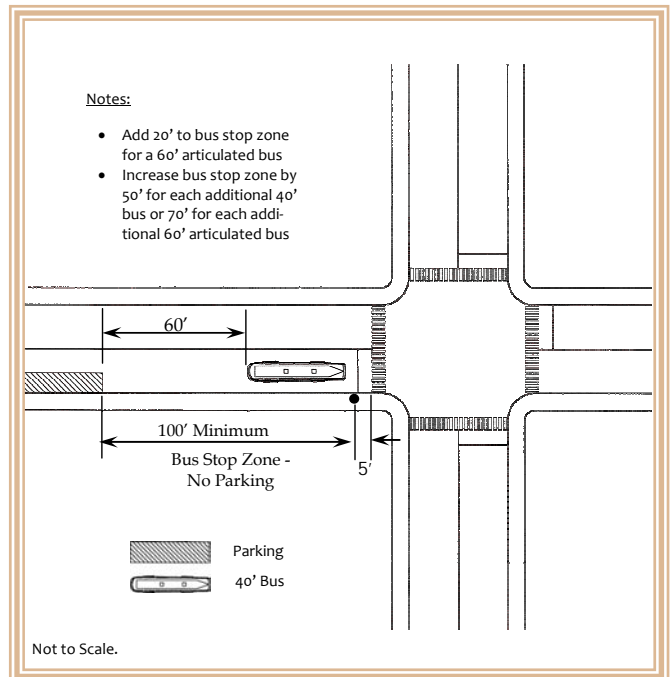

BUS STOP PLACEMENT, SPACING, AND TYPE

Mid-Block Stops

Figure 3 provides a diagram with the recommended dimensions for a typical mid-block bus stop. Mid-block bus stops are generally not preferred and should be avoided whenever possible. A situation that may necessitate a mid-block bus stop is where:

- The major trip generators that are between intersections and cannot be served at the nearest intersection

Accessibility Factors

Whether the bus stop is placed near-side, far-side, or mid-block, the bus stop location must have adequate sidewalk connections, and roadway crossing amenities (i.e. marked crosswalks, median islands, curb ramps, pedestrian signals, etc.). Detailed information on the design of these accessibility factors can be found in the *Americans with Disabilities Act Accessibility Guidelines (ADAAG)* and the *Federal Highway Administration's 2008 Pedestrian Safety Guide for Transit Agencies*.

Figure 3. Mid-Block Bus Stop Location

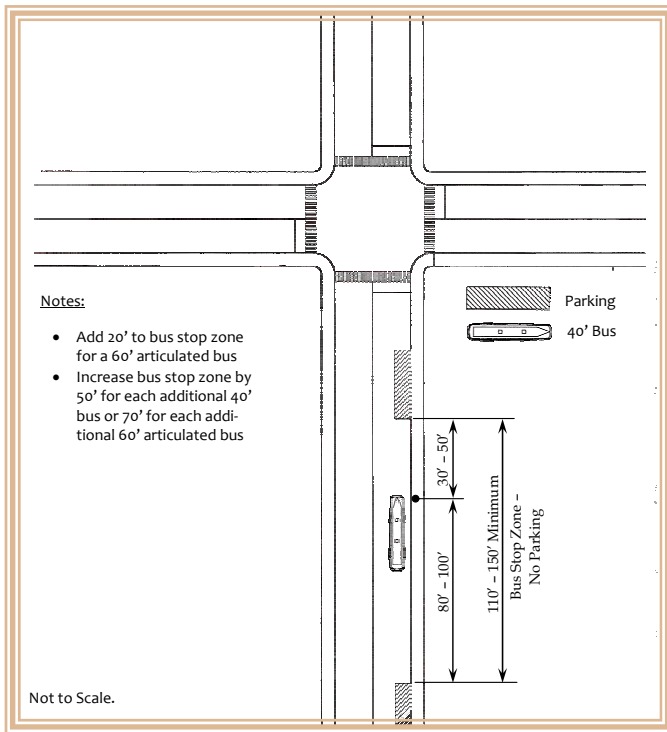

BUS STOP PLACEMENT, SPACING, AND TYPE

Bus Stop Spacing

Description

The spacing of bus stops is an optimization issue that attempts to balance the needs of passengers and operators. A greater distance between bus stops presents a reduced number of potential occurrences of deceleration/acceleration, and therefore has the possibility to reduce the overall operating time of the route enough to provide customers with a more rapid ride. If time savings are significant (for example, an overall time savings of at least five minutes per trip), the transit system may be able to reduce the number of buses out on the road needed to meet headway guidelines. The disadvantage to having a greater distance between bus stops is that some customers will be required to walk further to the nearest stop, and may find this inconvenience enough of a deterrent to choose transit, or even a hardship that prevents them from being able to ride (because of a mobility limitation). Ultimately, bus stops should be spaced closely enough that passengers can walk to them easily, but far enough apart to allow for greater bus efficiencies. Ultimately, bus stops should be spaced closely enough that passengers can walk to them easily, but far enough apart to help buses decelerate less and move quicker.

Usage Factors

The spacing guideline for all local services should be established at a consistent distance throughout the length of the bus service, to ensure expedited service through more densely populated areas, and adequate service in less populated areas. Some research has been conducted on the optimal spacing of bus stops, and according to one such study: *Municipal Benchmarks: Assessing Local Performance and Establishing Community Standards* by Ammons, which studied bus stop spacing standards for a number of agencies, the optimal bus stop spacing typically ranged from 656 – 1,968 feet (200-600 meters) in urban areas. The results of optimization studies such as Ammons details that the findings of the research show that the current spacing between bus stops is in contrast to what is found to be optimal. As a compliment to local service, more distantly-spaced stops are recommended for enhanced bus service such as limited stop or BRT type service, which is designed to operate as an enhanced bus service (overlapped by a “local” bus service with more frequent stops for customers who would otherwise have too long of a walk to a bus stop, and correspondingly slower service).

Another optimal spacing case study, conducted by Li and Bertini at Portland State University’s Department of Civil & Environmental Engineering, examined a route operated by TriMet in Portland, Oregon. The model developed in the case study took into account several variables including the Access Cost (the number of passenger boardings and alightings at each stop, and the passenger access speed versus the stop spacing impacts on passenger walking distance), and the Riding and Stopping Cost (the in-vehicle waiting time for bus passengers during boarding and alighting). The case study determined that the optimal average spacing for the examined route was 1,222 feet (4.3 stops/mile) compared to the existing average spacing of 942 feet. Additional research titled *Optimal Bus Stop Spacing through Dynamic Programming and Geographic Modeling* by Furth and Rahbee looked at the impacts of changing bus stop spacing on a bus route. The study modeled a bus route in Boston and determined the optimal spacing for the assessed route to be an average of 1,200 feet (4.5 stops/mile), which was in sharp contrast to the existing average spacing of 600 feet (8 stops/mile).

Design Factors

Although employing bus stop spacing guidelines is fairly common, the guidelines themselves may vary from jurisdiction to jurisdiction. Agencies generally have their own guidelines and operate it based on local needs. The following guidelines are recommended for spacing of Metrobus service bus stops in the region:

Local Bus Service

- 4-5 bus stops per mile

Enhanced Service/Limited Stop Service

- 2-3 bus stops per mile

Commuter/Express Stop Service

- Vary depending on major employment destinations and high boarding locations

BUS STOP PLACEMENT, SPACING, AND TYPE

Accessibility Factors

The recommended bus stop spacing should serve as a guide. The addition or subtraction of bus stop locations need to take into consideration the existing transit network, trip generators, land uses, and pedestrian infrastructure. Bus stops need to have adequate sidewalk connections and roadway crossing amenities (i.e. marked crosswalks, median islands, curb ramps, pedestrian signals, etc.).

BUS STOP PLACEMENT, SPACING, AND TYPE

On-Street Bus Stop

Description

On-street bus stops are those where the bus stops are in the:

- travel lane,
- parking lane, or
- shoulder

These types of bus stops are the most frequently used because of their operating efficiency. They provide easy access for bus operators and have minimal delays to service. In addition, these types of stops can be established, relocated, or eliminated with relative ease.

Usage Factors

Although on-street bus stops are the most common and the easiest to establish, there are some site considerations when evaluating a location for an on-street stop. Some of these site considerations include:

- Posted speed limit not to exceed 40 mph
- Adequate street lighting
- Proximity to controlled intersections
- Availability of pedestrian facilities (i.e. sidewalk, crosswalks, pedestrian signals)
- Adequate curb clearance to accommodate buses pulling in and out of bus stop zone (applicable to stops in the parking lane or shoulder)
- Adequate right-of-way of passenger amenities and wheelchair access

Design Factors

Bus Stop in Travel Lane

Bus stops where the bus is stopped in the travel lane require minimum design and are the simplest of the three types of on-street bus stops to establish. Stops in the travel lane should be avoided at locations with high volumes of passenger activity, at which the bus may be stopped for significant periods of time and could potentially disrupt the flow of traffic. Figure 4 provides a diagram of a standard on-street bus stop in the travel lane.

Figure 4. On-Street Stop in Travel Lane

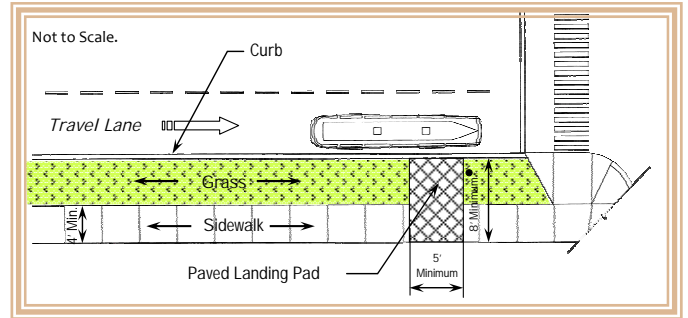

Bus Stop in Parking Lane

This type of design is illustrated in Figure 5. The bus stopping area and acceleration/deceleration area needs to be designated as “no parking” with enforcement, to ensure parked cars do not block bus access to the curb and render the stop inaccessible to customers who use wheelchairs. As a result of the parking capacity that is reduced, an alternative may be a curb bulb (Figure 7), which will help to mitigate some of the loss of parking.

Figure 5. On-Street Stop in Parking Lane

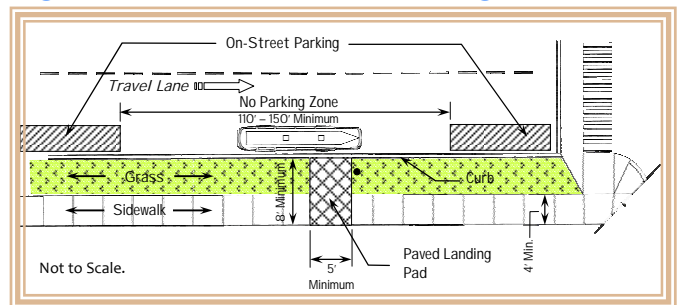

Bus Stop on Shoulder

Unless the entire shoulder is “No Parking at Any Time,” the bus stopping area and acceleration/deceleration area needs to be designated as “no parking” with enforcement, to ensure parked cars do not block bus access to the curb (thereby making the stop inaccessible to customers who use wheelchairs). This type of design is illustrated in Figure 6.

Figure 6. On-Street Stop on Shoulder

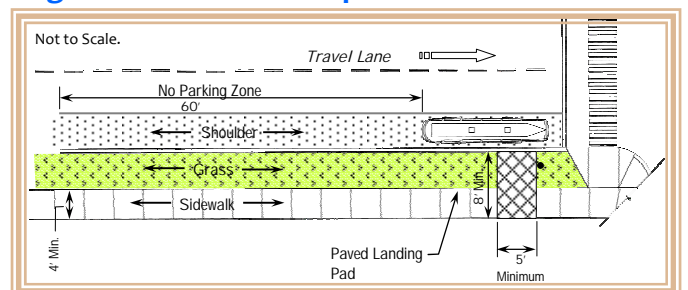

BUS STOP PLACEMENT, SPACING, AND TYPE

Accessibility Factors

Transit buses should have access to the curb adjacent to the bus stop particularly for stops that are in a parking lane or shoulder. This will allow safe access for all types of passengers to board and alight the bus. In addition, on-street bus stops should be located so that the front door of the stopped bus aligns with the ADA landing pad.

Curb Bulb

Description

Curb bulbs are sometimes referred to as curb extensions or nubs, sidewalk extensions, or bulb-outs. Curb bulbs are used at locations with curbside parking. A portion of the sidewalk extends out to the travel lane, thus allowing most of the curbside parking to remain, while providing a connection between the travel land and the sidewalk. Curb bulbs maximize the amount of on-street parking around bus stops while minimizing needed curb clearance.

Usage Factors

Curb bulbs should be located:

- In areas where curbside parking is critical
- In areas with limited curb clearance
- In areas where buses experience delays in re-entering the traffic lane
- In areas where traffic calming is desired
- Where there are no restrictions on parking

Design Factors

Figure 7 provides a diagram of curb bulb design. Curb bulbs should be 30' to 40' wide for a standard 40' transit bus that has front and rear doors. For a 60' articulated transit bus the curb clearance should be 50' to accommodate rear door access.

Figure 7. Curb Bulb

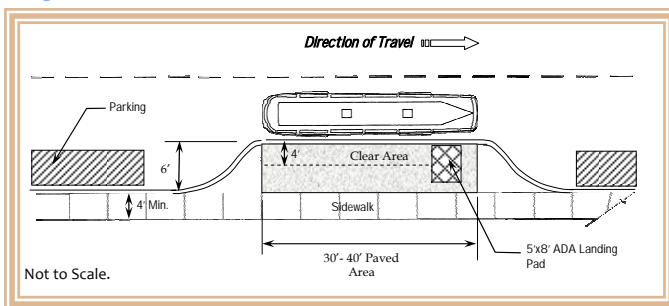

Accessibility Factors

To prevent obstructions to the front and/or rear doors of the bus, a 4' wide area adjacent to the curb needs to be clear of such items as trash receptacles, vendor boxes, utility poles, benches, and shelters. The paved area of the curb bulb should be connected to a 4' wide sidewalk.

Bus Bay

Description

Bus bays can come in several forms, depending on land use, roadway design, traffic flows, and available right-of-ways. Bus bays allow buses to pick up and drop off passengers outside of the travel lane. As a result, this allows traffic to flow unobstructed while the bus is stopped. The primary types of bus bays are:

- Parallel bus bays
- Sawtooth bus bays

Usage Factors

Locations that should be considered for bus bays are:

- Traffic speeds exceeding 40mph
- Average peak-period dwell time exceeds 30 seconds per bus
- Buses that are expected to lay over
- Multiple buses serve the stop at the same time
- History of vehicles colliding into rear of bus

Design Factors

Parallel Bus Bays

This type of stop is sometimes referred to as a bus bay, turn-out, or berth. Parallel bus bays are constructed as an inset into the curb. There are two types of parallel bus bays, closed bus bays and open bus bays. Closed bus bays have tapered ends for acceleration and deceleration, while an open bus bay has one tapered end either for acceleration or deceleration, but not both. Closed bus bays are preferred because it provides the greatest level of protection for buses with the minimal amount of disturbance to traffic. The bus stop zone, including the deceleration and acceleration areas, should be designated as "no parking". The surface area of the bus stop zone should be constructed of concrete. Figure 8 illustrates the general layout and dimensions of a bus bay for one 40' bus, along with the appropriate length of the acceleration and deceleration lanes.

BUS STOP PLACEMENT, SPACING, AND TYPE

Figure 8. Parallel Bus Bay

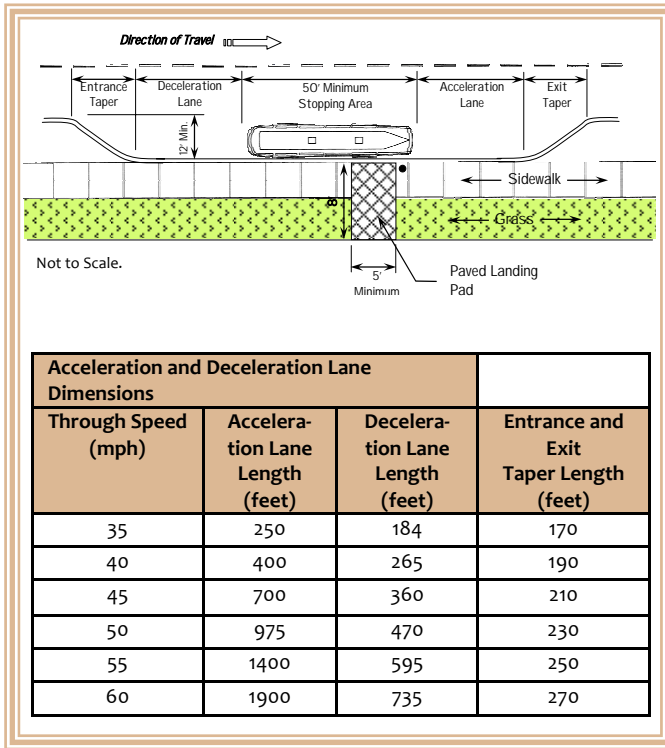

Source: TCRP 19: Guidelines for the Location and Design of Bus Stops.

Sawtooth Bus Bay

In off-street bus stopping areas, such as bus transfer centers, rail stations, and park and ride lots, sawtooth bus bays are recommended for their efficient use of constrained curb space. Sawtooth bays are generally wider than parallel bays, but require shorter curbside clearances. Sawtooth bays can also work effectively along curved lanes and curbside facilities. Metro’s *Station Site and Access Planning Manual* indicates that sawtooth bays are the standard design for Metro bus facilities. Figure 9 provides a diagram of a sawtooth bus bay illustrated in the *Station Site and Access Planning Manual*. While the design of an off-street bus bay depends on the individual site characteristics, Figures 10 and 11 provides examples of other sawtooth bus bay designs.

Figure 9. Metro Sawtooth Bus Bay

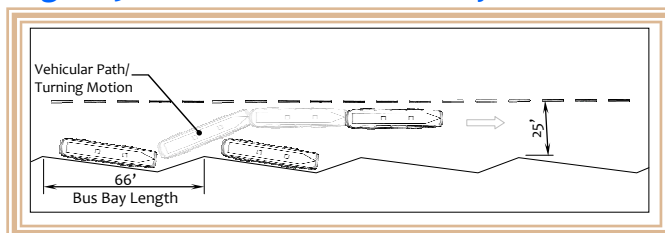

Source: Metro Station Site and Access Planning Manual

Figure 10. Sawtooth Bus Bays in Florida

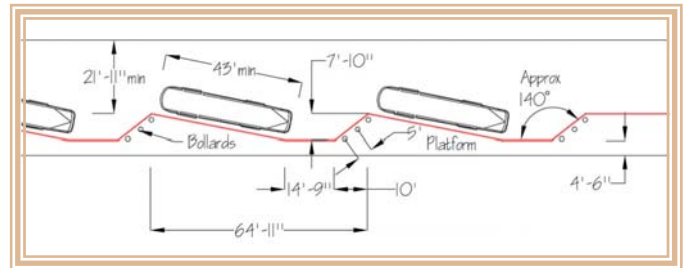

Source: Accessing Transit—Designing Handbook for Florida Bus Passenger Facilities.

Figure 11. AC Transit Sawtooth Bus Bays

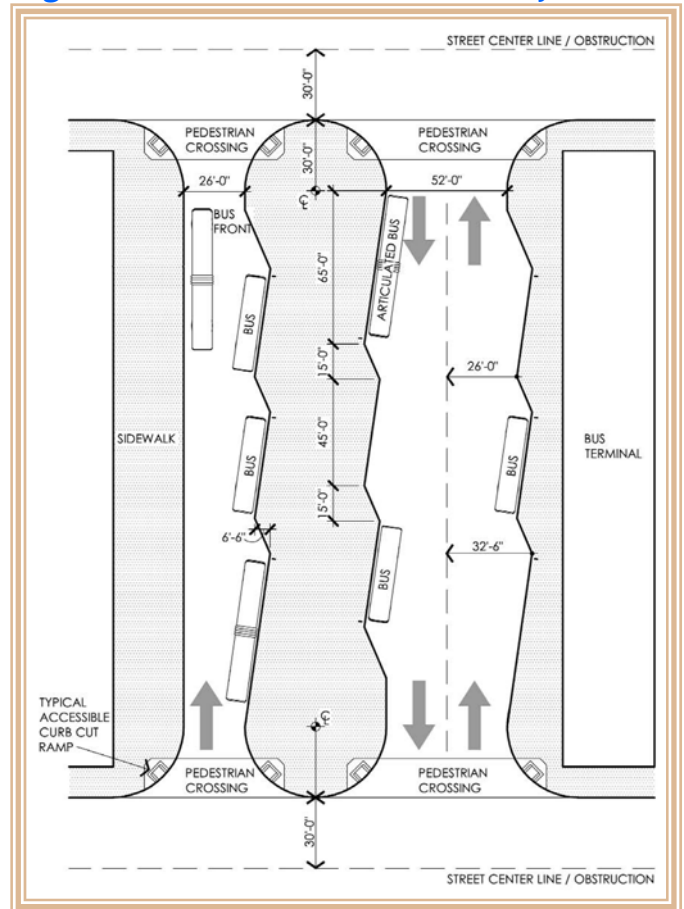

Source: AC Transit, Alameda-Contra Costa Transit District, California.

BUS STOP ELEMENTS AND PASSENGER AMENITIES

Bus Stop Hierarchy

Description

For many transit agencies and jurisdictions, resources for providing and improving passenger facilities are limited, requiring them to prioritize what and where improvements will be made. These improvements can be for safety, accessibility, and/or comfort and convenience.

Usage Factors

Table 2 provides a hierarchy of bus stop types that will provide a guide on the provision of bus elements and passenger amenities for the different classes of bus stops:

- Basic
- Enhanced Bus Service
- Transit Center

In addition to the recommended bus stop elements and passenger amenities for each bus stop class in Table 2, other factors to consider are:

- Total daily boardings
- Number of routes serving the stop
- Special populations served by the stop
- Potential for stop sponsorship

Table 2. Bus Stop Hierarchy

Bus Stop Element/ Passenger Amenity	Basic Stop	Enhanced Service Bus Stop	Transit Center
Bus Stop Sign	Yes	Yes	Yes
ADA 5'x8' Landing Pad	Yes	Yes	Yes
Sidewalk	Yes	Yes	Yes
Lighting	Evening Service	Yes	Yes
Seating	Trip Generator Based	Yes	Yes
Expand Boarding & Alighting Area (Rear-door access)	No	Site Specific	Yes
Bus Bay (Pull Off)	No	Site Specific	Yes
Shelter(s)	1 (50+ boardings/day)	1	2 +
Trash Receptacle	Site Specific	Yes	Yes
Information Case	Yes	Yes	Yes
System Map	Contingent on Shelter	Yes	Yes
Real-time Display (LED + Audio)	Optional	Yes	Yes
Interactive Phone System On-Site	No	No	Yes

Bus Stop Sign

Description

Bus stop signs help customers and bus operators identify the designated location of the bus stop. The bus stop sign also publicizes the services and routes that are served by the stop.

Usage Factors

Each active bus stop location should be marked with a bus stop sign.

Design Factors

Placement of the sign should take into consideration customer convenience, safety, and stop visibility. Minimum information on the bus stop sign should include:

- Operator name/logo
- Contact information (i.e. phone number, website)
- Route numbers/names

The sign must be easily visible to the approaching bus driver and be clear of the side mirrors of buses, preferably 2' to 4' from the face of the curb. Other design considerations include:

- Sign should neither obstruct or be obstructed by other street signs
- Locate sign far-side (downstream) from the bus loading area
- Sign should be securely mounted on its own post
- Sign should be perpendicular to the street
- Metrobus sign should be mounted above other transit operator signs (applicable to stops served by Metrobus and other providers) as shown in Figure 12

Figure 12. Example of Metrobus Sign Placement at Shared Stops

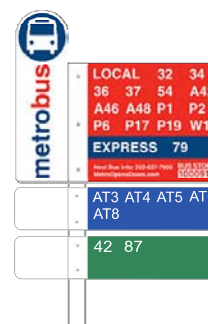

BUS STOP ELEMENTS AND PASSENGER AMENITIES

Accessibility Factors

Bus stop signs should conform to ADAAG requirements for height, width, and visibility. The bottom edge of the sign should be positioned at a height of at least 80" above the ground. Signs mounted on bus stop shelters should also have a space of 80" to 98" from the base of the sign to the ground. ADAAG requirements for information related accessibility include:

- Non-glare finish for characters and background
- Characters contrasted with background with either light characters on a dark background or dark characters on a light background
- Fonts must be of appropriate size, proportion
- Character spacing between individual characters must be between 10% to 35% of character height
- Spacing between lines must be between 135% to 170% of the character height

For more information on the accessibility of signs refer to the ADAAG Section 4.3.

Bus Stop Sign Post

Description

Bus stop posts provide a way to securely mount passenger information and amenities such as the bus stop sign, information case, and real time information.

Usage Factors

It is preferred that all bus stop locations should have their own bus stop posts. Using other types of posts such as utility poles, traffic sign posts, and light poles should be avoided.

Design Factors

Bus stop sign posts should be installed far-side of the boarding area and be rust resistant, painted white, and uniform in design. Shelters designed to accommodate bus stop signs can be used in lieu of a bus stop post.

Accessibility Factors

Bus stop posts should be distinguishable from other posts in the same area so it is more identifiable by riders with visual impairments. To further assist riders with visual impairments in identifying the location of the bus stop, consideration should be given to mounting a tactile sign (Figure 13) with the word Metro or letter M 40" to 54" on-center above ground on the bus stop post.

Other solutions could include a Remote Infrared Audible System also referred to as a Talking Sign.

Figure 13. Example of a Tactile Sign to Indicate the Location

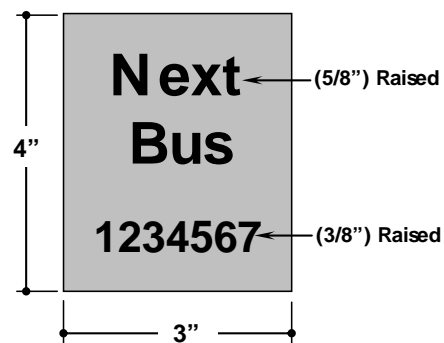

Information Cases

Description

Information cases are used to display route, schedule, and system information. The cases can be installed on a bus stop post or be part of the overall design of a passenger shelter.

Usage Factors

Information cases should be installed at all bus stop locations, particularly at high activity locations and stops that serve as transfer points between routes.

Design Factors

Information cases are generally mounted on the bus stop posts, but can be part of the overall design of the passenger shelter. Cases that are mounted on the bus stop posts can be either rectangular or cylindrical. Although the bus schedules, timetables, and maps that are posted in the information case are not subject to ADAAG, the information case itself must meet relevant ADAAG requirements to ensure that they do not create a potential hazard for pedestrians. The information case may overhang up to 12 inches when located between 27" to 80" above the ground. Figure 14 provides examples of information cases that are used throughout the region.

Accessibility Factors

There two primary types of installation for a post mounted information case, stationary and rotational. The type of information case and installation may vary by jurisdiction but a paved access (minimum of 36" wide) to all transit information displayed in the case must be

BUS STOP ELEMENTS AND PASSENGER AMENITIES

provided. An advantage of an information case that is able to rotate around the bus stop post is that paved access only needs to be provided on one side of the case. It should be noted that cylindrical cases may distort the text and make it difficult to read for some.

Figure 15 provides recommended placement of an information case. Placing an information case between 48” to 67” on-center from the ground is the most comfortable viewing height for most ambulatory and wheelchair users.

Figure 14. Examples of Post Mounted Information Cases



Figure 15. Suggested Viewing Heights

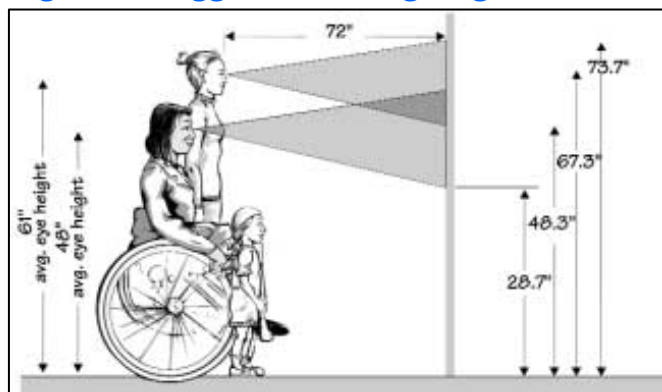

Source: Design for Accessibility: A Cultural Administrator's Handbook.

Lighting

Description

Adequate lighting at bus stop facilities allow bus drivers and approaching traffic to see waiting passengers at night. Lighting also provides added security for those waiting at the stop, in addition to illuminating route and schedule information for patrons.

Usage Factors

Bus stop locations that are served in the evenings should have adequate lighting.

Design Factors

Lighting can be provided by a nearby streetlight, ambient light from the adjacent businesses, lighting installed within the shelter, or a stand-alone light pole. Transit stops without sheltered lighting should be located within 30 feet of an overhead light source. Bus stop light fixtures or shelter illumination should be between 2.0 to 5.0 footcandles. However, shelter lighting should be on the lower range as to not create a spotlight affect, where it is difficult for passengers waiting inside the shelter to see outside. As an alternative to a hard-wired light pole or sheltered lighting, a solar-powered “stop call light” on the bus stop pole or shelter may provide an as-needed source of light.

BUS STOP ELEMENTS AND PASSENGER AMENITIES

ADA Landing Pad/Passenger Waiting Area

Description

An ADA landing pad provides greater access to transit services for wheelchair users, the elderly, and other encumbered riders such as parents with strollers. Another benefit to providing an adequate waiting area is that passengers waiting for the bus will be set back further from the curb and the flow of traffic.

Usage Factors

Establishing a bus stop with just a post and sign does not automatically trigger the need for an ADA landing pad unless other improvements such as shelters are constructed. However, in order to further increase access to transit services to all, it is recommended that ADA landing pads should be installed, to the extent possible, at all bus stop locations. Stops which cannot be rendered accessible obligates the transit provider to offer ADA complementary paratransit for customers who could otherwise use the accessible stop. Larger passenger waiting areas should be considered at bus stops with a high volume of passengers.

Design Factors

Figure 16 are examples of some common landing pad designs. Landing pads can be connected to the backside of the sidewalk or located between the curb and sidewalk. The design of an landing pad should take into the following considerations:

- Surface should be slip resistant
- Constructed of hard, solid material
- Connected to curb
- Ensure proper water run off to avoid standing water
- Avoid using catch basins as part of or all of the landing pad/passenger waiting area

Accessibility Factors

The landing pad should conform to the guidelines outlined in the ADAAG (Section 10.2.1).

- 5' wide (parallel to the roadway) by 8' deep (perpendicular to the roadway)
- Free from obstructions
- Connected to sidewalks and streets by an accessible path
- Slope of the pad parallel to the roadway shall be the same as the roadway
- Cross slope not to exceed 1:50 (2%)

Figure 16. Examples of Landing Pads



Landing pad on the front side of the sidewalk.

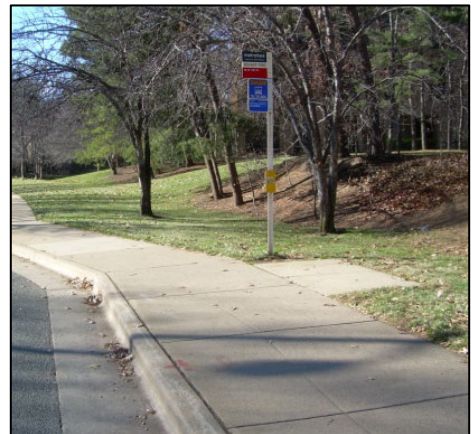

Landing pad on the backside of the sidewalk.



Expanded landing pad.

BUS STOP ELEMENTS AND PASSENGER AMENITIES

Benches

Description

Benches can be freestanding or part of a shelter design. It provides seating for passengers waiting for the bus particularly at locations where service is less frequent.

Usage Factors

Benches are recommended at bus stop locations that are near sites that attract riders who may have difficulty walking and standing, particularly at stops where headways are longer than 15 minutes.

Design Factors

Benches should be fabricated of durable materials resistant to vandalism and weather conditions. The design of the bench should:

- Coordinate with an appearance appropriate to the neighborhood
- Discourage people from sleeping on the bench.
- Allow for proper water run off
- Seat should be 20 to 24 inches in depth and minimum 42 inches in length; back support minimum of 18 inches high, positioned at a maximum of 2 inches above seat; seat height to be 17 to 19 inches above ground (Figure 17)
- Installed at least 4' from the back-face of the curb

Figure 17. Bench Dimensions

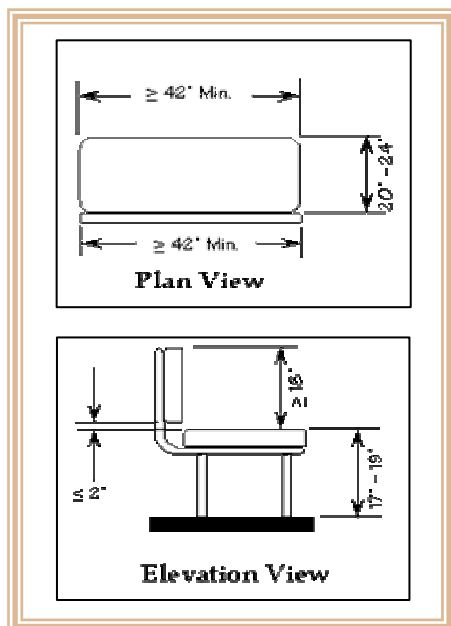

Accessibility Factors

While a bench can provide added comfort at a bus stop, the following should be taken into consideration:

- Locate on non-slip, concrete or asphalt pad
- Do not install on 5'x8' landing pad
- Do not obstruct sidewalk access
- Do not obstruct access to customer information

Figure 18 provides illustrations of appropriate bench placements.

Figure 18. Bench Placements

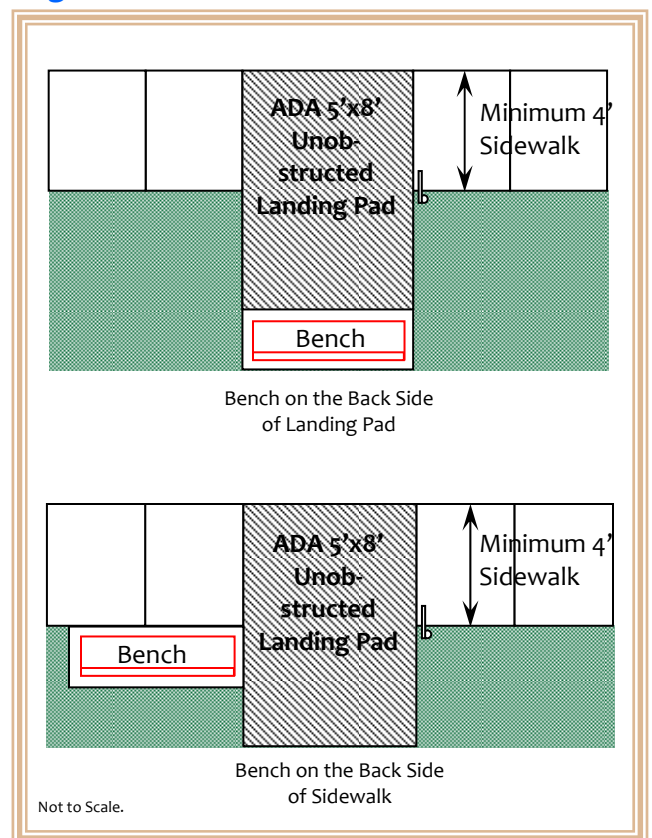

BUS STOP ELEMENTS AND PASSENGER AMENITIES

Passenger Shelter

Description

Passenger shelters help to shield riders waiting for the bus from the sun and in climate weather. The type and style of shelters will depend on the preferences of the local municipalities and communities.

Usage Factors

Passenger shelters are recommended for all bus stops with 50 or more daily boardings, enhanced service stops, and transit centers. Bus stop locations that serve senior communities, colleges/universities, hospitals, major trip generators, other special trip generators, and major transfer points between routes may also be suitable for passenger shelters. Larger or multiple shelters should be used at stops with at least 100 daily boardings.

Design Factors

A shelter can range from an overhead canopy to being a fully enclosed structure. The most common type of passenger shelters in the region are semi-enclosed shelters. Figure 19 are examples of current shelter designs and types in the region. Shelters should be oriented so they are placed facing the travel lane and near-side of the landing pad. Shelters should be clean and maintained on a regular basis. The design of passenger shelters should take into consideration the following:

- Provide seating on the inside
- Material should be durable and resistant to vandalism and weather conditions
- Transparent sides for greater visibility; panels should be shatterproof and marked with reflectors; panels should be resistant to fading and clouding
- Space for name of stop
- Shelter lighting
- Provision for bus shelter maps
- Advertising placement should not obstruct the view of approaching traffic
- Do not locate within 2' of the back face of the curb
- Provision for push button audio for Nextbus real time bus arrival information



Figure 19. Examples of Shelter Designs



District of Columbia (double shelter)



District of Columbia



Montgomery County



Prince George's County



Alexandria

BUS STOP ELEMENTS AND PASSENGER AMENITIES

Accessibility Factors

The design and placement of passenger shelters need to ensure adequate access and maneuverability for those with mobility limitations. To ensure bus stop and shelter access for customers, the following should be considered:

- Clear area 36" wide by 48" deep completely within shelter
- Entrance to be a minimum of 36" wide; though an open face shelter is preferred
- Adequate maneuvering space outside of shelter entrance
- Clear unobstructed path to shelter entrance
- Shelter should not obstruct ADA landing pad
- Shelter should not obstruct sidewalk
- Unobstructed access to customer information (i.e., area map, Nextbus audio push button) on shelter

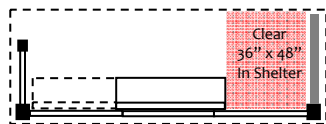

- Access to information cases
- Access to shelter or information/maps displayed on shelter
- Access to audio push button for real time bus information (where applicable)

Vendor Boxes

Description

Vendor boxes, also referred to as newspaper boxes, can be an added convenience to customers.

Usage Factors

Vendor boxes are generally found at locations where there is a high level of pedestrian activity.

Design Factors

To ensure that vendor boxes are appropriately placed, the use of "corrals/condos" should be considered. Vendor box corrals/condos will provide a designated location and/or storage of publications at the bus stop. Figure 20 shows examples of a vendor box corral/condo.

Trash Receptacles

Description

Trash receptacles can help to control litter and maintain a stop's cleanliness. It is important to properly maintain the receptacles and the trash collection.

Usage Factors

Trash receptacles should be provided at bus stops that are served by enhanced bus service and at transit centers. Bus stops that have a problem with litter and stops in proximity to fast food establishments and convenient stores should have trash receptacles.

Design Factors

Trash receptacles at bus stops should resemble other publicly owned and maintained trash receptacles along the corridor. The receptacles should be secured to the ground to prevent accidental tipping or unauthorized movement.



Accessibility Factors

Trash receptacles should be installed where they do not create an obstruction or interfere with the:

- ADA landing pad

Figure 20. Examples of Corral/Condo



Accessibility Factors

As with any street furniture, vendor boxes need to comply with the ADAAG with regards to its placement. Vendor boxes cannot reduce the clear spaces required by the ADAAG, and therefore, cannot be located on the 5'x8' ADA landing pad, or obstruct access to the stop, the shelter, or any customer information. In addition, vendor boxes cannot be secured to any bus stop feature such as the bus stop post, trash receptacle, bench, or shelter. Vendor boxes in violation of these guidelines must be relocated or removed.

BUS STOP ELEMENTS AND PASSENGER AMENITIES

Shelter Maps

Description

The Metro bus shelter maps are attractively-designed posters that capture helpful customer information onto one concise layout.

Usage Factors

The maps are currently installed at Metrorail stations and other key stops. The installation of the maps are to be installed on the remaining sheltered stops throughout the region.

Design Factors

Figure 21 provides an example of the current bus shelter map. The maps are typically bolted to the shelter with the exception of the Pentagon Station, where for security purposes, they are adhered to the glass. The information provided on the maps include:

- A regional map with all Metrobus and Metrorail lines, Metrorail stations, routes operated by locally operated public transit providers, points of interest locations, “You Are Here” label, and major roadways
- A close-up of the central Washington, D.C. area
- A close-up of the immediate neighborhood
- A table of all routes serving the station/bus stop with the approximate frequency of service on weekdays, Saturdays, and Sundays

Accessibility Factors

As with all customer information at a bus stop, adequate access needs to be provided. Access to the map should be clear of all obstructions.

Figure 21. Bus Shelter Map

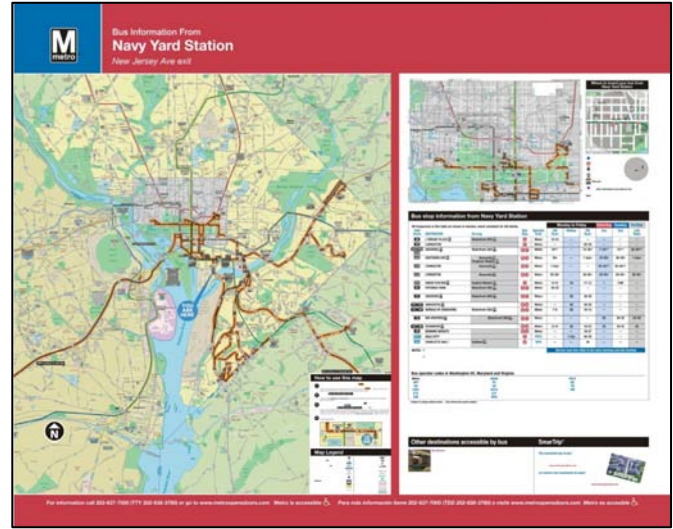

BUS STOP PROTOTYPES

Basic Bus Stop

Description

Basic stops constitute the majority of bus stops in the region.

Usage Factors

Basic stops provide access to transit in many types of environments and can be adjacent to a variety of land uses. Stops are generally along arterial roadways and local roads.

Design Factors

Non-Sheltered Bus Stops

Figures 22 through 24 provide diagrams of several types of non-sheltered stops:

- Sidewalk adjacent to curb (Figure 22)** - In this type of bus stop, a paved pad extends 4' deep and 5' wide from the backside of a 4' wide sidewalk to create a clear unobstructed 5'x8' ADA landing pad. The bus stop pole is placed at the back of the sidewalk and off the ADA landing pad so it does not pose an obstruction. Clear, unobstructed, paved access is also provided to the information case.
- Sidewalk setback from the curb (Figure 23)** - In this type of bus stop, a 4' wide grass strip separates the curb and a 4' wide sidewalk. A paved 5' wide pad is installed to connect the sidewalk to the curb, creating a 5'x8' ADA landing pad. The front edge of the bus stop sign is located at least 2' from the back of the curb and off the ADA landing pad and sidewalk. A clear unobstructed paved access is also provided to the information case.
- Expanded Landing Pad (Figure 24)** - In this type of bus stop, the passenger loading area is expanded to provide more space for pedestrian and patron movement and better accommodation for rear door alighting. The loading area should be a paved 30' to 40' wide (50' to 60' for an articulated bus) adjacent to the curb. The expanded loading area 4' from the curb should be clear of any obstructions (i.e., trash receptacles, vendor boxes, planter boxes, benches, utility poles, etc.).

For each type of bus stop, a 40' wide clear, unobstructed zone set back 3' from the curb is recommended. This will allow passengers to safely alight from the rear door of the bus unimpeded.

Figure 22. Sidewalk Adjacent to Curb

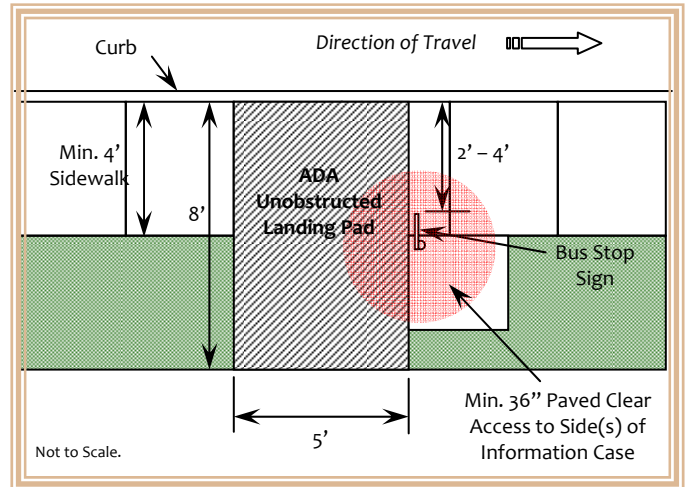

Figure 23. Sidewalk Setback from Curb

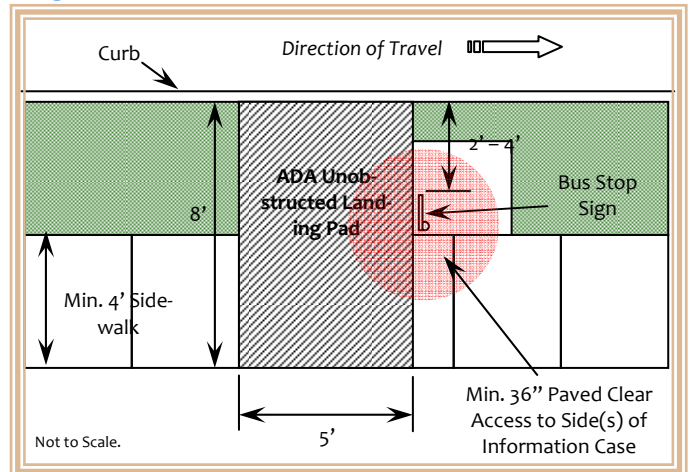
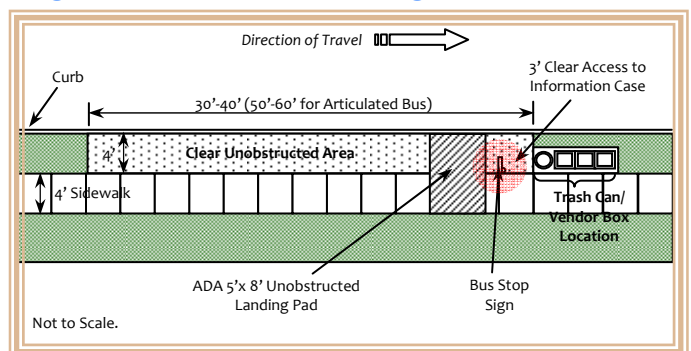

Figure 24. Expanded Landing Pad



Accessibility Factors

The bus stop and landing pad should be connected to an accessible sidewalk. Street crossings should be connected by curb ramps and crosswalks.

BUS STOP PROTOTYPES

Sheltered Bus Stop

Description

Sheltered bus stops provide waiting passengers cover from the elements such as sun, rain, wind, and snow.

Usage Factors

Sheltered stops should be at locations with 50 or more daily boardings, stops served by enhanced bus service, and transit centers.

Design Factors

The layout and configuration of a sheltered bus stop will frequently depend on the available rights-of-way, the type of stop, and the pedestrian infrastructure. Figures 25 and 24 provide several configurations for a sheltered bus stop.

- ADA landing pad in front of shelter** - Figure 25 provides two bus stop prototypes with the ADA landing pad in front of the shelter. The first prototype is based on the sidewalk being adjacent to the curb. Therefore part of the sidewalk is used as the ADA landing pad. This configuration can be used when there is minimum right-of-way on the far-side and near-side of the stop. The second prototype also places the ADA landing pad in front of the shelter, but is configured based on the sidewalk being setback from the curb. In this configuration, the conflict between the flow of pedestrians and waiting customers are minimized since the sidewalk is behind the shelter and the bus stop loading area.
- ADA landing pad far-side of shelter** - Figure 26 illustrates a sheltered bus stop with the ADA landing pad far-side of the shelter. This type of design requires adequate rights-of-way upstream and/or downstream of the stop. Locating the ADA landing pad far-side of the shelter will allow the bus to fully pull into the bus stop zone and the wheelchair lift to align with the ADA landing pad. The roof of the shelter must be at least 4 feet from the back of the curb to avoid being struck by transit or commercial bus side mirrors.

Figure 25. ADA Landing Pad in Front of Shelter

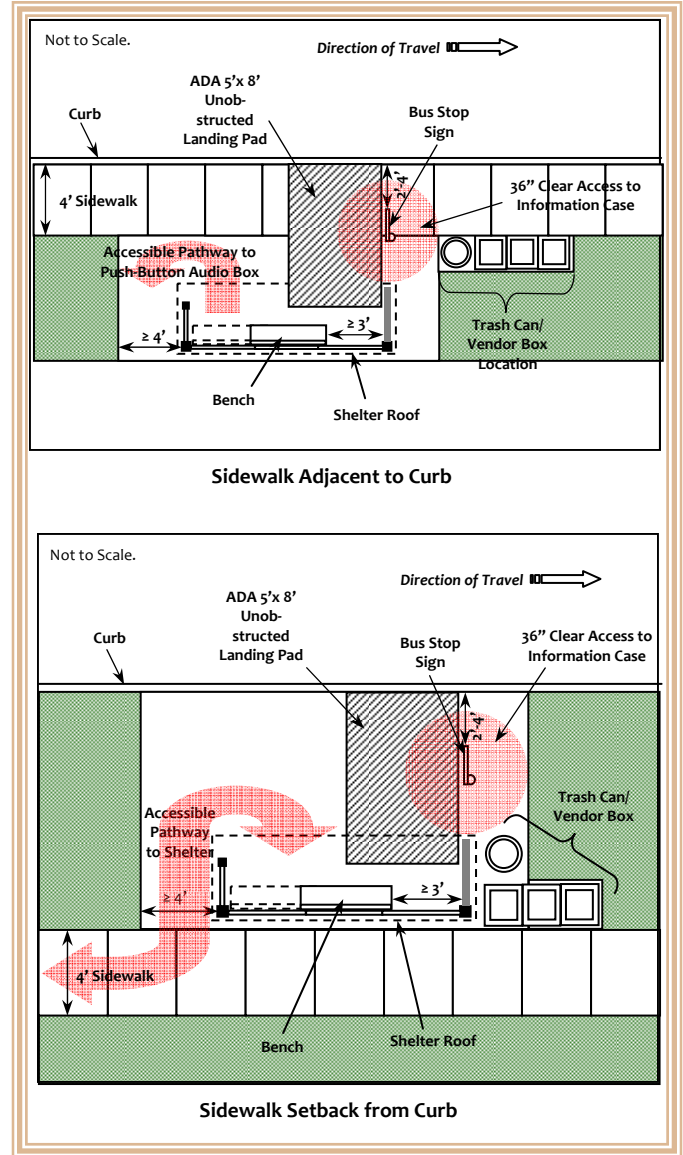
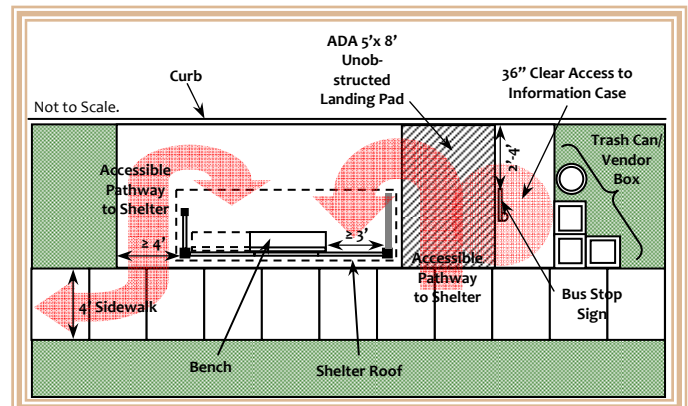
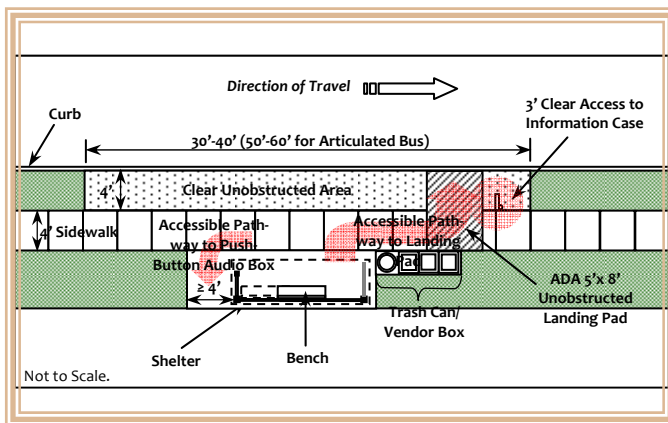

Figure 26. ADA Landing Pad Far-side of Shelter



- **Enhanced Service Bus Stop** - Figure 27 provides a prototype of a sheltered bus stop served by an enhanced type of service (such as express or limited stop) or experiences a higher level of passenger activity and pedestrian flow. The stop consists of a 30' to 40' (50' to 60' for an articulated bus) clear, paved, unobstructed area. The shelter is placed on the backside of the sidewalk as to not impede pedestrian flow.

Figure 27. Enhanced Service Stop with Shelter



Accessibility Factors

The bus stop waiting area/shelter should be connected to the ADA landing pad by an unobstructed accessible pathway. The 4' wide paved area adjacent to the curb should be clear of street furniture, vendor boxes, trash receptacles, and any potential obstructions to the front and rear loading area. The bus stop zone should be connected with accessible sidewalks, and street crossings should be connected by curb ramps and crosswalks.