



metro

Washington
Metropolitan
Area
Transit
Authority

**Request
For
Proposal
[Federal]**

RFP No. FQ15011

**Enterprise Hybrid Cloud Backup and
Recovery Solution**

RFP NO. FQ15011

Date: May 13, 2014

**Washington Metropolitan Area Transit Authority
RFP No. FQ15011**

Date: May 13, 2014

SUBJECT: RFP No. FQ15011

Dear Sir/Madam:

The Washington Metropolitan Area Transit Authority (WMATA) requires the services of a qualified contractor to provide hardware and support for the use of Enterprise Hybrid Cloud Backup and Recovery for two (2) data center locations, Jackson Graham Building (JGB) and Carmen Turner Facility (CTF). The Contractor will provide the hardware, software, install and provide maintenance and support services.

If you have any questions, Technical, Contractual, or Administrative, please e-mail them to Benjamin T. Kpadeh, bkpadeh@wmata.com no later than Close of Business, May 23, 2014 at 12:00 PM EST. WMATA will provide written responses, by email to all those who obtained the Request-for-Proposals (RFP) and provided their e-mail addresses.

Your proposal must be received with all required submittals as stated in the RFP, no later than 12:00PM EST, June 13, 2014, at Attn: Benjamin T. Kpadeh, RFP No. FQ15011, WMATA, Office of Procurement and Materials, 600 Fifth Street, NW, Room 3C-02, Washington, DC 20001-2651.

Sincerely



William R. Walters
Contracting Officer
Office of Procurement and Materials

Enclosure:

Washington Metropolitan Area Transit Authority
RFP No. FQ15011

INTRODUCTORY INFORMATION
SOLICITATION CERTIFICATIONS PAGE

RFP N. FQ15011

ENTERPRISE HYBRID CLOUD BACKUP and RECOVERY SOLUTION

APPROVED FOR RELEASE



Angela Y. Lee
Project Manager/Office Designee



Date



William R. Walters
Contracting Officer



Date



COUN

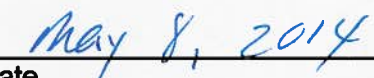

Date

END OF SECTION

TABLE OF CONTENTS

DIRECTIONS FOR SUBMITTING OFFER	1
NOTICE TO OFFERORS	3
NOTICE TO ALL VENDORS	4
SOLICITATION, OFFER AND AWARD	5
PRICE SCHEDULE SHEET	7
SOLICITATION INSTRUCTIONS	8
1. DEFINITIONS	8
2. PREPARATION OF OFFERS	9
3. EXPLANATION TO OFFERORS	9
4. PRIOR REPRESENTATIONS	10
5. ACKNOWLEDGMENT OF AMENDMENTS	10
6. PRE-PROPOSAL CONFERENCE	10
7. REVISIONS PRIOR TO DATE SET FOR RECEIPT OF PROPOSALS	10
8. SUBMISSION OF OFFERS	10
9. LATE SUBMISSIONS, MODIFICATIONS, AND WITHDRAWALS OF OFFERS	11
10. PROPOSAL GUARANTEE	12
11. CONTRACT AND BONDS	12
12. MINIMUM PROPOSAL ACCEPTANCE PERIOD	13
13. CONTRACT AWARD	13
14. DISADVANTAGED BUSINESS ENTERPRISES REQUIREMENTS	14
15. OPPORTUNITY FOR DISADVANTAGED BUSINESS ENTERPRISES TO PROPOSE	14
16. NOTICE OF PROTEST POLICY	14
17. PRE AWARD INFORMATION	15
18. PROPOSAL FORMAT INSTRUCTIONS/REQUIREMENTS	15
19. RESTRICTION ON DISCLOSURE AND USE OF DATA	16
20. AWARD	16
21. BASIS FOR AWARD (Technically Acceptable – Low Price)	16
22. PROPOSAL EVALUATION CRITERIA	17
23. RATINGS FOR PROPOSAL EVALUATION CRITERIA	18
24. DEFINITIONS FOR TECHNICAL EVALUATION	18
25. PRICE PROPOSAL EVALUATION	19
26. TYPE OF CONTRACT	19
27. ENGLISH LANGUAGE AND UNITED STATES CURRENCY	19
28. FEDERAL/LOCAL/STATE SALES TAX	19
29. BRAND NAME OR EQUAL	20
REPRESENTATIONS AND CERTIFICATIONS	22
REPRESENTATIONS	22
1. TYPE OF BUSINESS ORGANIZATION	22
2. AFFILIATION AND IDENTIFYING DATA	22
3. PREVIOUS CONTRACTS AND COMPLIANCE REPORTS	22
4. DISADVANTAGED BUSINESS ENTERPRISE	23
5. AFFIRMATIVE ACTION COMPLIANCE	23

CERTIFICATIONS	23
6. COVENANT AGAINST GRATUITIES	23
7. CONTINGENT FEE.....	23
8. CLEAN AIR AND WATER CERTIFICATION.....	24
9. DEBARMENT, SUSPENSION, INELIGIBILITY, AND VOLUNANTARY EXLCUSION	24
10. CERTIFICATION OF INDEPENDENT PRICE DETERMINATION	25
11. CERTIFICATION OF NONSEGREGATED FACILITIES.....	25
12. NONDISCRIMINATION ASSURANCE.....	26
13. CERTIFICATION OF RESTRICTIONS ON LOBBYING.....	26
14. BUY AMERICA ACT CERTIFICATION.....	27
15. CERTIFICATION OF NON-DELINQUENT TAXES.....	28
16. DISCLOSURES OF INTERESTS OF WMATA BOARD MEMBERS.....	29
PRE-AWARD EVALUATION DATA.....	31
PART II, SECTION 1 - GENERAL PROVISIONS	35
1. DEFINITIONS.....	35
2. ACCOUNTING AND RECORD KEEPING.....	36
3. ASSIGNMENT	38
4. AUDIT RECORDS-NEGOTIATION.....	38
5. CERTIFICATE OF CURRENT COST OR PRICING DATA	40
6. CHANGES.....	40
7. NONDISCRIMINATION ASSURANCE.....	40
8. CONFLICT OF INTEREST	42
9. CONTRACT WORK HOURS AND SAFETY STANDARDS ACT-OVERTIME COMPENSATION	43
10. CONVICT LABOR.....	44
11. CORRECTION OF DEFICIENCIES.....	44
12. COST OR PRICING DATA.....	47
13. COVENANT AGAINST CONTINGENT FEES.....	48
14. DEFAULT	48
15. DELAY OF WORK.....	50
16. RESOLUTION OF DISPUTES	50
17. EMPLOYMENT RESTRICTION WARRANTY	51
18. EXTRAS.....	52
19. FEDERAL, STATE AND LOCAL TAXES.....	52
20. GRATUITIES.....	53
21. INSPECTION OF SERVICES.....	54
22. INSPECTION OF SUPPLIES.....	55
23. LIMITATION ON WITHHOLDING PAYMENTS	57
24. NEW MATERIAL.....	57
25. NOTICE AND ASSISTANCE REGARDING PATENT AND COPYRIGHT INFRINGEMENT.....	57
26. NOTICE TO THE AUTHORITY OF LABOR DISPUTES.....	58
27. OFFICIALS NOT TO BENEFIT.....	58
28. ORDER OF PRECEDENCE	58
29. PATENT AND RIGHTS IN DATA.....	58
30. PATENT INDEMNITY	61
31. PAYMENTS.....	61
32. PAYMENT DEDUCTIONS - NONCOMPLIANCE WITH DBE REQUIREMENTS.....	62

33. PRICE REDUCTION FOR DEFECTIVE COST OR PRICING DATA — PRICE ADJUSTMENTS	62
34. PRICING OF ADJUSTMENTS	63
35. RESPONSIBILITY FOR INSPECTION	64
36. RETENTION OF DOCUMENTS	64
37. RIGHTS IN TECHNICAL DATA	64
38. ROYALTY INFORMATION	66
39. SEAT BELT USE POLICY	66
40. SENSITIVE SECURITY INFORMATION	66
41. STOP WORK ORDER	66
42. SUBCONTRACT PAYMENTS	67
43. SUBCONTRACTOR COST AND PRICING DATA-PRICE ADJUSTMENTS	68
44. TERMINATION	68
45. TITLE AND RISK OF LOSS	73
46. VARIATION IN QUANTITY	73
47. WALSH-HEALEY PUBLIC CONTRACTS ACT	73
SUPPLEMENTAL PROVISIONS REQUIRED IN FEDERALLY FUNDED CONTRACTS	74
48. ACCESS TO THIRD PARTY CONTRACT RECORDS	74
49. BUY AMERICA	74
50. CARGO PREFERENCE	74
51. CLEAN AIR	75
52. CLEAN WATER	75
53. CONTRACTS INVOLVING FEDERAL PRIVACY ACT REQUIREMENTS	75
54. ENERGY CONSERVATION	76
55. CHANGES TO FEDERAL REQUIREMENTS	76
56. FLY AMERICA	76
57. DEBARMENT OR SUSPENSION	76
58. INCORPORATION OF FEDERAL TRANSIT ADMINISTRATION (FTA) TERMS	77
59. LOBBYING	77
60. NO FEDERAL GOVERNMENT OBLIGATIONS TO THIRD PARTIES	77
61. FALSE STATEMENTS OR CLAIMS CIVIL AND CRIMINAL FRAUD	77
62. RECOVERED MATERIALS	78
63. RIGHTS IN DATA AND COPYRIGHTING - FTA	78
PART II, SECTION 2 - SPECIAL PROVISIONS	81
1. PERIOD OF PERFORMANCE	82
2. DELIVERY SCHEDULE	82
3. OPTION QUANTITIES	82
4. AVAILABILITY OF FUNDS FOR THE NEXT FISCAL YEAR	82
5. PRICING	82
6. PAYMENT TERMS	82
7. BILLING AND PAYMENT	83
8. POINT OF CONTACT	83
9. F.O.B. DESTINATION	83
10. CONTRACTOR PERSONNEL	84
11. PRE-EMPLOYMENT CRIMINAL BACKGROUND CHECK REQUIREMENT	84
12. MOST FAVORED CUSTOMER	85
13. CONDITIONS AFFECTING THE WORK	85

14. WARRANTY	85
16. GENERAL INSURANCE REQUIREMENTS	86
17. BOND REQUIREMENTS	88
18. PROPOSAL SECURITY	89
19. LAWS AND REGULATIONS	89
20. PRIME CONTRACTOR DBE RESPONSIBILITIES	89
21. FEDERAL/LOCAL/STATE SALES TAX	89
22. CONTRACTING OFFICER’S TECHNICAL REPRESENTATIVE (COTR)	90
23. HAZARDOUS MATERIAL IDENTIFICATION AND MATERIAL SAFETY DATA	92
24. SPECIAL DELIVERY INSTRUCTIONS	93
25. INSPECTION, TESTING AND ACCEPTANCE/VALIDATION	93
26. FIRST ARTICLE	94
27. ORGANIZATIONAL CONFLICT OF INTEREST	95
28. RIGHTS IN TECHNICAL DATA - UNLIMITED	95
29. LIQUIDATED DAMAGES	97
30. FORCE MAJEURE CLAUSE	97
31. SITE VISIT/INSPECTION	97
32. GARNISHMENT OF PAYMENTS	98
33. GOVERNING LAW	98
34. SAFETY REQUIREMENTS	98
35. LIVING WAGE	99
36. METRIC SYSTEM	100
37. SEISMIC SAFETY	100
38. RECYCLED PRODUCTS	100
39. NOTIFICATION OF FEDERAL PARTICIPATION	101
40. WHISTLEBLOWER PROTECTION	101
41. DRUG AND ALCOHOL TESTING	103
42. DAVIS-BACON AND COPELAND ANTI-KICKBACK ACTS (NOT APPLICABLE)	103
43. PUBLIC COMMUNICATION	103
MID-ATLANTIC PURCHASING TEAM RIDER CLAUSE	104
PART III TECHNICAL SPECIFICATIONS	105
APPENDIX A	114
APPENDIX B	115
APPENDIX C	116
APPENDIX D	117
APPENDIX E	118
APPENDIX F	119

DIRECTIONS FOR SUBMITTING OFFER

1. Read and comply with the Solicitation Instructions.
2. Envelopes containing Technical and Price proposals must be sealed and separately marked and addressed to:

WASHINGTON METROPOLITAN AREA TRANSIT AUTHORITY
Attn.: Benjamin T. Kpadeh/CA
RFP No. FQ15011
600 5th Street, NW
Room 3C-02
Washington, DC 20001

ALL ENVELOPES OR PACKAGES MUST BE SEPARATELY MARKED WITH SOLICITATION NUMBER AS SPECIFIED HEREWITH.

PROPOSAL SHALL BE TIMELY MAILED OR HAND DELIVERED TO REACH WMATA BEFORE 2:00 P.M. EST ON May 30, 2014 DAY OF PROPOSAL CLOSING.

Enterprise Hybrid Cloud Backup and Recovery Solution

Introduction

The Washington Metropolitan Area Transit Authority (WMATA) is issuing this solicitation on behalf of the Department of Information Technology (IT), Office of Data Center and Infrastructure (DCI), hereinafter referred to as "Authorized POC". The purpose of this Request-for-Proposals (RFP) is to seek for a qualified Contractor that will provide hardware and software that will include hardware and software support to create a highly enterprise hybrid cloud backup environment.

SUBMISSION OF PROPOSALS

Be advised that each submission must include a Proposal responsive to this RFP. Conditions, exclusions, or additions contained in the Proposal inconsistent with the RFP will deem it to be Non- Responsive, preventing consideration by WMATA.

Both Technical and Pricing Proposals should include an Introductory Summary or Synopsis limited to two pages maximum in which the principal concepts are delineated. Technical Terms as well as Financial Terms shall be well-defined in a category entitled 'Definitions.' Vague and inconsistent language is not acceptable. Comprehensiveness of the Proposal is necessary; partial submissions will not be accepted.

Proposers are advised that the Initial Proposal may be the only opportunity to present technical and financial information. Further, Pre-Award Information **must** be submitted with the Proposal and contained in a separate packet with other contract information. Contract Award may be made based upon the Initial Proposals only, without subsequent discussions, negotiations, and/or presentations; however, WMATA reserves the right to conduct discussions, negotiations, and presentations if it is deemed beneficial.

NOTICE TO OFFERORS

IN ORDER TO ENSURE THAT YOUR PROPOSAL COMPLIES WITH THE AUTHORITY'S PROCUREMENT REGULATIONS AND THAT IT WILL BE ACCEPTABLE TO THE AUTHORITY, THE FOLLOWING FORMS MUST BE COMPLETED & SUBMITTED AS SPECIFIED BELOW WITH YOUR OFFER:

- SOLICITATION, OFFER & AWARD FORM (**Must be signed**) - VOLUME III
- PRICE SCHEDULE- VOLUME I (**Submit one (1) original copy and one USB compatible thumb drive**)
-
- REPRESENTATIONS AND CERTIFICATIONS (**Must be signed**) - VOLUME III
- PRE-AWARD DATA (**Must be signed**) - VOLUME III
- ACKNOWLEDGMENT OF AMENDMENTS (IF ANY) (**Must be signed**) - VOLUME III
- TECHNICAL PROPOSAL VOLUME II (**The technical proposal shall not contain any cost/pricing information. Submit one (1) original copy and four (4) copies on paper and one USB compatible thumb drives**)
- PROOF OF INSURANCE ELIGIBILITY - VOLUME III
- APPENDIX B (IF APPLICABLE) - VOLUME III

FAILURE TO SUBMIT ANY PORTION OF THESE REQUIREMENTS AS SPECIFIED MAY CAUSE YOUR PROPOSAL TO BE CONSIDERED NON-RESPONSIVE AND SUBSEQUENTLY REJECTED.

Questions concerning this Request for Proposal may be directed to Benjamin T. Kpadeh via email at bkpadeh@wmata.com or by telephone at 202-962-2478 no later than May 23, 2014 at 12:00 PM EST.

NOTICE TO ALL VENDORS

Please be advised that all vendors and contractors who do business with the Washington Metropolitan Area Transit Authority (WMATA) must register in the WMATA Vendor Registration System. Registration is located at <http://www.wmata.com>
New Vendor Registration.

If you are a vendor or contractor and *HAVE* done business with WMATA in the past, please electronically request your company's User ID and Password at <http://www.wmata.com>
Forgot User Id/Password.

Attention to Disadvantaged Business Enterprise (DBE)/Small Business and Local Preference Program (SBLPP) companies:

Minority and women owned businesses who are interested in becoming a WMATA DBE should complete an online DBE application. Self certification is required for Small Business and Local Preference as a part of the Vendor Registration.

Registered Vendor Benefits:

- Visibility to WMATA contract administrators and/or purchasing agents during the purchasing decision period;
- Visibility to other 17,500 registered vendors for possible business opportunities;
- Opportunity to update online, company information such as an e-mail address or contact person on-line;
- Sign up for electronic payment option; and
- Ability to electronically reset User Id and Password.

Any questions regarding registration may be addressed to Vendor Relations at (202) 962-1408 or procurement@wmata.com.



**WASHINGTON METROPOLITAN AREA TRANSIT AUTHORITY
 SOLICITATION, OFFER AND AWARD**

CONTRACT NO.	SOLICITATION NO. RFP No. FQ15011 <input type="checkbox"/> ADVERTISED <input checked="" type="checkbox"/> NEGOTIATED	DATE ISSUED	ADDRESS OFFER TO OFFICE OF PROCUREMENT Office of Procurement 600 Fifth Street NW Washington, DC 20001
--------------	--	-------------	--

SOLICITATION

Sealed offer in original and TWO (2) copies for furnishing the supplies or services in the schedules will be received at Authority until 12:00 P.M. EST on 06/13/2014.
 (Hour) (Date)

If this is an advertised solicitation, offers will be publicly opened at that time.
CAUTION – LATE OFFERS: See paragraph 6 of Solicitation Instructions.

All offers are subject to the following:

1. The Solicitation Instructions which are attached.
2. The General Provisions, which are attached.
3. The Schedule included herein and/or attached hereto.
4. Such other provisions, representations, certifications, and specifications, as are attached or incorporated herein by reference.

Proposer's Phone Number _____ **Proposer's Fax Number** _____

SCHEDULE

ITEM NO.	SUPPLIES/SERVICES	QUANTITY	UNIT	UNIT PRICE	AMOUNT
	See Price Schedule Sheet (See continuation of schedule on page 7)				\$

DUN & BRADSTREET ID NUMBER: _____

OFFEROR

Name and Address (Street, city, county, state, and zip code)	Name and Title of Person Authorized to Sign Offer (Print or Type)
<input type="checkbox"/> Check if remittance is different from above — enter such address in Schedule	Signature Offer Date

AWARD (To be completed by The Authority)

ACCEPTANCE AND AWARD ARE HEREBY MADE FOR THE FOLLOWING ITEM(S):

ITEM NO.	QUANTITY	UNIT	UNIT PRICE

The total amount of this award is \$ _____

 Name of Contracting Officer (Print of Type) WASHINGTON METROPOLITAN TRANSIT AUTHORITY AWARD DATE

SOLICITATION, OFFER AND AWARD

CONTINUATION SHEET

THE UNDERSIGNED ACKNOWLEDGES RECEIPT OF THE FOLLOWING AMENDMENTS

TO SOLICITATION **RFP No. FQ15011**

Amendment Number _____	Dated _____
Amendment Number _____	Dated _____
Amendment Number _____	Dated _____
Amendment Number _____	Dated _____
Amendment Number _____	Dated _____
Amendment Number _____	Dated _____

Failure to acknowledge receipt of all amendments may render the offer unacceptable.

Authorized Signature

Company Name

Date

PRICE SCHEDULE SHEET

This is a Firm Fixed-Price Procurement

Description	Qty	Unit of Measure	Unit Price	Extended Price
Hardware CTF				
Backup Hardware and Software with Maintenance and Support	1			
Hardware JGB				
Backup Hardware and Software with Maintenance and Support	1			
			Total	

Authorized Signature

Company Name

Date

PRICE SCHEDULE SHEET
SOLICITATION INSTRUCTIONS

1. DEFINITIONS

As used herein:

“Clarifications” are limited exchanges, between the Authority and offerors, where offerors may be given the opportunity to clarify certain aspects of their proposals or to resolve minor irregularities, informalities or clerical errors.

“Descriptive literature” means information provided by an offeror, such as cuts, illustrations, drawings, and brochures that shows a product’s characteristics or construction of a product or explains its operation. The term includes only that information needed to evaluate the acceptability of the product and excludes other information for operating or maintaining the product.

“Discussions” are negotiations that may occur after receipt of proposals (generally after establishment of the competitive range) and before award that may, at the Contracting Officer’s discretion, result in the offeror being allowed to revise its proposal.

“Excluded Parties List System” means an electronic database maintained and posted by the General Services Administration containing the list of all parties suspended, proposed for debarment, debarred, declared ineligible, or excluded or disqualified under the nonprocurement common rule by agencies, Government corporations, or by the Government Accountability Office.

“In writing,” “writing,” or “written” means any worded or numbered expression that can be read, reproduced, and later communicated, and includes electronically transmitted and stored information.

“May” denotes the permissive. However, the words “no person may required, authorized, or permitted to do the act described.

☐” mean th

“Must” (see “shall”).

“Offer” means a response to a solicitation that, if accepted, would bind the offeror to perform the resultant contract. Responses to requests for proposals (negotiation) are offers called “proposals”; however, responses to requests for quotations (simplified acquisition) are “quotations,” not offers.

“Offeror” and “proposer” are synonymous and refer to the entity that submits an offer in response to this solicitation.

“Option” means a unilateral right in a contract by which, for a specified time, the Authority may elect to purchase additional supplies or services called for by the contract, or may elect to extend the term of the contract.

“Organizational conflict of interest” means that because of other activities or relationships with other persons, a person is unable or potentially unable to render impartial assistance or advice to the Authority, or the person’s objectivity in performing the contract work is or might be otherwise impaired, or a person has an unfair competitive advantage.

“Preaward survey” means an evaluation of a prospective contractor’s capability to perform a proposed contract.

“Proposal modification” is a change made to a proposal before the solicitation’s closing date and time, or made in response to an amendment, or made to correct a mistake at any time before award.

“Proposal revision” is a change to a proposal made after the solicitation closing date, at the request of or as allowed by a Contracting Officer typically as a result of discussions.

“Shall” means the imperative.

“Should” means an expected course of action or policy that is to be followed unless inappropriate for a particular circumstance.

"Solicitation" means "Request for Proposal (RFP)" where the procurement is negotiated.

“Will” (see “shall”).

2. PREPARATION OF OFFERS

- a. Offerors are expected to examine the Request for Proposals and all referenced documents carefully. Failure to do so will be at the risk of the Offeror.
- b. The Offeror shall furnish the information required by the solicitation. The Offeror shall sign the solicitation and print or type his/her/its name on the Schedule a offeror nd each Continuation Sheet thereof on which an entry has been made. Erasures or other changes must be initialed by the person signing the offer. Offers signed by an agent are to be accompanied by evidence of authority, unless such evidence has been previously furnished to the issuing office.
- c. Offers for supplies or services other than those specified will not be considered unless authorized by the solicitation.
- d. Offeror must state a definite time for delivery of supplies or for performance of services unless otherwise specified in the solicitation.
- e. Time, if stated as a number of days, will include Saturdays, Sundays and holidays.

3. EXPLANATION TO OFFERORS

Any explanation desired by an Offeror regarding the meaning or interpretation of the solicitation documents must be requested in writing and with sufficient time allowed for a reply to reach all Offerors before the submission of their offers. **Oral explanations or instructions given before the award of the contract will not be binding.** Any information given to an Offeror concerning a solicitation will be furnished promptly to all Offerors as an amendment of the solicitation, if that information is necessary in submitting offers or if lack of such information would be prejudicial to other Offerors. All Requests should be addressed as follows and submitted via e-mail, facsimile or mail Benjamin T. Kpadeh, bkpadeh@wmata.com , RFP No. FQ15011, Hybrid Cloud Storage Solution for Data Backup and Recovery.

4. PRIOR REPRESENTATIONS

The Authority assumes no responsibility for any understanding or representations concerning this solicitation made by any of its officers or agents prior to the issuance of the solicitation, the specifications, or related documents.

5. ACKNOWLEDGMENT OF AMENDMENTS

Receipt of an amendment to a solicitation by a Offeror must be acknowledged (a) by signing and returning the amendment, (b) by identifying the amendment number and date on the Solicitation, Offer and Award Form, (c) and by expressly acknowledging the amendment on the designated form and including it as part of the proposal. Such amendment must be received prior to the hour and date specified in the solicitation. If this solicitation is amended, then all terms and conditions which are not modified remain unchanged.

6. PRE-PROPOSAL CONFERENCE

OPTIONAL- Not Applicable (NA)

For the purpose of clarifying the terms, conditions, and requirements of this Request for Proposal, a pre-proposal conference will be held to respond to questions by interested offerors. **This pre-proposal conference will be held at N/A a.m/p.m. on N/A, in the Lobby Level Meeting Room of the WMATA Jackson Graham Building, 600 5th Street, NW, Washington, DC 20001.** The purpose of this conference will be to answer questions regarding, or requests for clarifications of, the solicitation documents. It is requested that offerors submit their questions in writing whether in advance of the meeting or during the meeting. Questions from the floor, however, are permissible.

All questions concerning the terms, conditions, and requirements of this Request for Proposal must be received by the Contracting Officer in writing no later than ten (10) calendar days before the date for receipt of proposals.

7. REVISIONS PRIOR TO DATE SET FOR RECEIPT OF PROPOSALS

- a. The right is reserved by the Authority to revise or amend the Scope of Work, Description of Work, drawings, etc. prior to the date set for the opening of proposals. Such revisions and amendments, if any, will be announced by an amendment to the Request for Proposal. Copies of such amendments as may be issued will be furnished to all prospective proposers.
- b. If the revisions and amendments require material changes in quantities or price proposals, or both, the date set for the opening of proposals may be postponed by such number of days as in the opinion of the Authority that will enable offerors to revise their proposals. In such cases, the amendment will include an announcement of the new date for the opening of proposals.

8. SUBMISSION OF OFFERS

- a. Offers and modifications thereof shall be enclosed in sealed envelopes and addressed to the office specified in the solicitation. The Offeror shall show the hour and date specified in the solicitation for receipt, the solicitation number, and the name and address of the Offeror on the face of the envelope.

- b. Telegraphic offers will not be considered unless authorized by the solicitation; however, offers may be modified or withdrawn by written or telegraphic notice, provided such notice is received prior to the hour and date specified for receipt.
- c. Facsimile offers, modifications or withdrawals will not be considered unless authorized by the Authority.

9. LATE SUBMISSIONS, MODIFICATIONS, AND WITHDRAWALS OF OFFERS

- a. Any offer received at the office designated in the solicitation after the exact time specified for receipt will not be considered unless it is received before award is made and it
 - (1) Was sent by registered or certified U.S. mail not later than the fifth calendar day before the date specified for receipt of offers (e.g., an offer submitted in response to a solicitation requiring receipt of offers by the 20th of the month must have been sent by registered mail by the 15th;
 - (2) Was sent by mail or, if authorized by the solicitation, was sent by telegram or via facsimile and it is determined by the Authority that the late receipt was due solely to mishandling by the Authority after receipt;
 - (3) Was sent by U.S. Postal Service Express Mail Next Day Service Post Office to Addressee, not later than 5:00 p.m. at the place of mailing two working days prior to the date specified for receipt of offers. The term "working days" excludes weekends and U.S. Federal holidays; or
 - (4) Is the only offer received.
- b. Any modification of an offer, except a modification resulting from the Contracting Officer's request for "revised final proposals" offer, is subject to the same conditions as in subparagraphs (a)(1), (2), and (3) of this provision.
- c. A modification resulting from the Contracting Officer's request for "revised final proposals" received after the time and date specified in the request will not be considered unless received before award and the late receipt is due solely to mishandling by the Authority.
- d. The only acceptable evidence to establish the date of mailing of a late offer, modification, or withdrawal sent by registered or certified mail is the U.S. or Canadian Postal Service postmark on the envelope or wrapper and on the original receipt from the U.S. or Canadian Postal Service. Both postmarks must show a legible date or the offer, modification or withdrawal shall be processed as if mailed late. "Postmark" means a printed, stamped, or otherwise placed impression (exclusive of a postage meter machine impression) that is readily identifiable without further action as having been affixed by employees of the U.S. or Canadian Postal Service on the date of mailing. Therefore, Offerors should request the postal clerk to place a legible hand cancellation bull's eye postmark on both the receipt and the envelope or wrapper.
- e. The only acceptable evidence to establish the time of receipt by the Authority is the time/date stamp of that installation on the proposal wrapper or other documentary evidence of receipt maintained by the Authority.
- f. The only acceptable evidence to establish the date of mailing of a late offer, modification, or withdrawal sent by Express Mail Next Day Service Post Office to Addressee is the date entered by the post office receiving clerk on the "Express Mail Next Day Service Post

Office to Addressee" label and the postmark on both the envelope or wrapper and on the original receipt from the U.S. Postal Service. "Postmark" has the same meaning as defined in paragraph (d) of this provision, excluding postmarks of the Canadian Postal Service. Therefore, Offeror or Quoter should request the postal clerk to place a legible hand cancellation bulls-eye postmark on both the receipt and the envelope or wrapper.

- g. Notwithstanding paragraph "a" above, a late modification of any otherwise successful offer that makes its terms more favorable to the Authority will be considered at any time it is received and may be accepted.
- h. Proposals may be withdrawn by written notice or telegram (including mailgram) received at any time before award. If the solicitation authorizes facsimile proposals, proposals may be withdrawn via facsimile received at any time before award, subject to the conditions specified in the provision entitled "Facsimile Proposals". Proposals may be withdrawn in person by an Offeror or an authorized representative, if the representative's identity is made known and the representative signs a receipt for the proposal before award.

10. PROPOSAL GUARANTEE

OPTIONAL - NOT APPLICABLE

A proposal guarantee is required by the Request for Proposal. Failure to furnish a proposal guarantee in the proper form an amount with the Price Proposal, by the time set for the receipt of proposals may be cause for rejection of the proposal.

A proposal guarantee shall be in the form of a firm commitment, such as a proposal bond (form supplied in Section _____), postal money order, certified check, cashier's check, irrevocable letter of credit from a State or Federally chartered bank or, in accordance with Treasury Department regulations, certain bonds or notes of the United States. Corporation executing the proposal bond as sureties must be among those appearing on the Treasury Department's list of approved sureties and must be acting within the limitations set forth therein. Proposal guarantees, other than proposal bonds, will be returned as follows:

To unsuccessful proposers: As soon as practicable after the receipt of proposals.

- a. To the successful proposer: Upon execution of such further contractual documents and bonds as may be required by the proposal as accepted.
- b. If the successful proposer, upon acceptance of its proposals by the Authority within the Acceptance Period, fails to execute such further contract documents and give such bond(s) as may be required by the terms of the contract, its contract may be terminated for default. In such event, the successful proposer shall be liable for any cost of procuring the work which exceeds the amount of its proposal, and the proposal guarantee shall be available toward offsetting such difference.

11. CONTRACT AND BONDS

OPTIONAL – NOT APPLICABLE

The proposer whose Technical and Price Proposal are accepted, shall, within the time established in the contract documents, enter into a written contract with the Authority and furnish performance bonds if applicable, on standard Authority forms in the amounts indicated in the General Provisions of the contract.

12. MINIMUM PROPOSAL ACCEPTANCE PERIOD

- a. "Acceptance period," as used in this provision, means the number of calendar days available to WMATA for awarding a contract from the date specified in this solicitation for receipt of proposals.
- b. This provision supersedes any language pertaining to the acceptance period that may appear elsewhere in this solicitation.
- c. WMATA requires a minimum acceptance period of 90 calendar days from the latest revised proposal.

13. CONTRACT AWARD

If this solicitation is a Request for Proposals:

- a. The Authority will award a contract resulting from this solicitation to the responsible Offeror whose offer conforming to the solicitation will be most advantageous to the Authority cost or price and other factors, specified elsewhere in this solicitation, considered.
- b. The Authority may (1) reject the offer if such action is in the public interest, or (2) waive informalities and minor irregularities in offers received.
- c. The Authority may award a contract on the basis of the initial offer received, without discussions (other than discussions conducted for the purpose of minor clarifications). Therefore, the initial offer should contain the Offeror's best terms from a cost or price and technical standpoint. However, the Authority reserves the right to conduct discussions if later determined by the Contracting Officer to be necessary.
- d. A written award or acceptance of offer mailed or otherwise furnished to the successful Offeror within the time for acceptance specified in the offer shall result in a binding contract without further action by either party. Before the offer's specified expiration time, the Authority may accept an offer (or part of an offer, as provided in paragraph (d) above) whether or not there are negotiations after its receipt, unless a written notice of withdrawal is received before award. Negotiations conducted after receipt of an offer do not constitute a rejection or counteroffer by the Authority.
- e. Neither financial data submitted with an offer, nor representations concerning facilities or financing will form a part of the resulting contract. However, if the resulting contract contains a clause providing for price reduction for defective cost or pricing data, the contract price will be subject to reduction if cost or pricing data furnished is incomplete, inaccurate, or not current.
- f. The Authority may determine that an offer is unacceptable if the prices proposed are materially unbalanced between line items or sub-line items. An offer is materially unbalanced when it is based on prices significantly less than cost for some work and prices which are significantly overstated in relation to cost for other work, and if there is a reasonable doubt that the offer will result in the lowest overall cost to the Authority even though it may be the low evaluated offer, or it is so unbalanced as to be tantamount to allowing an advance payment.

14. DISADVANTAGED BUSINESS ENTERPRISES REQUIREMENTS

Attached as part of this solicitation are documents outlining the requirements for the Disadvantaged Business Enterprise (DBE) Program: **The DBE requirement goal for this contract is twenty percent (25%) unless a good faith waiver is requested and approved.**

- a. If the offer is over \$100,000, and for the Offeror to be considered responsible, the following documents (see Appendix B) shall be completed and submitted with the offer:

Schedule of DBE Participation

Letter of Intent to Perform as Subcontractor/Joint Ventur
(If applicable)

DBE Unavailability Certification
(where applicable)

Written request for waiver when DBE participation is less than stated percent

DBE Monthly Status Report, after award, to the COTR and a final report at contract completion if DBE participation is applicable.

The provisions of Appendix B (if attached) do not become applicable and forms do not have to be completed, unless the total offer is \$100,000 or more. If the offer is \$100,000 or more and any portion of the written requirement is omitted, then the offer may be found to be unacceptable and subsequently rejected. Appendix B forms and/or waivers must be completed with great care by each Offeror to insure that the offer is acceptable.

15. OPPORTUNITY FOR DISADVANTAGED BUSINESS ENTERPRISES TO PROPOSE

The Washington Metropolitan Area Transit Authority hereby notifies all Offerors that it will affirmatively ensure that disadvantaged minority business enterprises will be afforded full opportunity to submit offers in response to this solicitation and will not be discriminated against on the basis of race, color, or national origin in consideration for award.

16. NOTICE OF PROTEST POLICY

- a. WMATA policy and procedure for the administrative resolution of protests is set forth in Chapter 17 of the Authority's Procurement Procedures Manual (PPM). Chapter 17 contains strict rules for filing a timely protest, for responding to a notice that a protest has been filed, and other procedural matters. The Contracting Officer can furnish a copy of Chapter 17 upon request.
- b. FTA Circular 4220.1F, addresses Protests. FTA will only review protests regarding the alleged failure of the grantee to have a written protest procedure or alleged failure to follow such procedures, and only when submitted by an interested party. The term "interested party" is defined in the Authority policy for handling protests.
- c. Alleged violation on other grounds must be submitted to the Contracting Officer who will decide the protest.

- d. The judicial authorities having jurisdiction over court actions concerning protest decisions are the United States District Courts for the Districts of Maryland, Virginia, and the District of Columbia, and the local courts in Maryland, Virginia, and the District of Columbia.

17. PRE AWARD INFORMATION

- a. Before making a determination of responsibility, the Contracting Officer shall possess or obtain information sufficient to satisfy the applicable standards and requirements for responsibility set forth in this Chapter.
- b. The Contracting Officer shall obtain information regarding the responsibility of a prospective contractor whose offer is in the competitive range. The prospective contractor shall promptly supply information requested by the Contracting Officer regarding its responsibility. If the prospective contractor fails to supply the information requested, the Contracting Officer shall make a determination of nonresponsibility based upon the lack of available information.
- c. The Contracting Officer shall use the following sources of information, listed in priority order to support responsibility determinations:
 - (1) General Services Administration publication titled "System for Award Management" ("SAM"), formerly the "Excluded Parties List System." The results of the search must be printed and placed in the contract file;
 - (2) Written records and experience data, including verifiable knowledge of Authority personnel, and other sources, i.e.: publications, suppliers, subcontractors, and customers of the prospective contractor, financial institutions, government agencies, and business and trade associations. Contract Administrators and other Authority personnel who become aware of circumstances casting doubt on a contractor's ability to perform a contract successfully shall promptly inform the Contracting Officer and furnish the relevant information in writing;
 - (3) Information supplied by the prospective contractor, including proposal information, questionnaire replies, financial data, information on production equipment and personnel information; and
 - (4) Pre-award survey reports.

18. PROPOSAL FORMAT INSTRUCTIONS/REQUIREMENTS

The Offeror shall submit their proposal as follows:

a. Proposal Format

The original of Volumes 1 and 2 shall be unbound, all copies of Volumes 1 and 2, as well as Volume 3 will be separately bound and all copies shall have the RFP number, the Offeror's identity, volume number, and volume title printed on the cover page. Volumes shall be submitted in the following order:

- (1) Volume I – Cost/Price - One (1) original AND one (1) USB compatible thumb drive of the cost/price proposal

- (2) Volume II – Technical - One (1) original, four(4) copies of the technical proposal AND one (1) USB compatible thumb drive of the technical proposal (**Shall not include cost/price information**)
 - (3) Volume III – Contractual - One (1) original one (1) copy AND one (1) USB compatible thumb drive of the completed signed solicitation documents to include Representations, Certifications, Pre-Award Data, Certificate of Insurance, DBE requirements, per Appendix B and Amendments, if any.
- b. All information relating to cost or pricing data must be included in this volume. Under no circumstances shall cost or pricing data be included elsewhere in the Offeror's proposal. **CA may include any additional information pertaining to Price Proposal.**
 - c. Technical Proposal. The technical proposal shall enable WMATA evaluating personnel to make a thorough evaluation and arrive at a sound determination as to whether or not the proposal will meet the specifications in accordance with the Authority's requirements. Technical proposals shall be specific, detailed, and complete and demonstrate that the Offeror has a thorough knowledge and understanding of the requirements. Offerors shall avoid statements which paraphrase the specifications or attest that "standard procedures will be employed," are inadequate to demonstrate how it is proposed to comply with the requirements of the specifications, and this clause.
 - d. Contractual. Contractual documents shall contain a completed signed Solicitation, Offer and Award Form and include Representations, Certifications, Pre-Award Data, Certificate of Insurance, DBE requirements, per Appendix B and any amendments.

19. RESTRICTION ON DISCLOSURE AND USE OF DATA

The Authority shall provide all reasonable precautions to insure that proprietary, technical and pricing information remains within the review process. Offerors shall attach to any proprietary data submitted with the solicitation the following legend:

- a. "This data furnished pursuant to this RFP shall not be disclosed outside the Authority, be duplicated, or used in whole or in part, for any purpose other than to evaluate the offer; provided that, if a contract is awarded on the basis of that offer, the Authority shall have the right to duplicate, use, and disclose this data, in any manner and for any purpose whatsoever.
- b. This information does not limit the Authority's right to use information contained in this data if it is or has been obtained by the Authority from another independent legitimate source.
- c. Except for the foregoing limitation, the Authority may duplicate, use, and disclose in any manner and for any purpose whatsoever and have others so do, all data furnished in response to this solicitation."

20. AWARD

The Authority will make one contractor for all line items in the schedule of prices resulting from this solicitation.

21. BASIS FOR AWARD (Technically Acceptable – Low Price)

TECHNICALLY ACCEPTABLE – LOW PRICE

- a. The Authority will award a contract resulting from this solicitation to the responsible Offeror whose offer conforms to the solicitation and is determined to be the lowest priced among those offers rated “Technically Acceptable.”

The Authority may (1) reject any or all offers if such action is in WMATA’s interest, (2) accept other than the lowest offer, and (3) waive minor informalities and irregularities in offers received.

- b. Offeror’s are advised that the award may be made without discussions or any contact with the offerors concerning the offers received except for minor clarifications. However, the Authority reserves the right to conduct discussions if later determined by the Contracting Officer to be necessary. Therefore, each initial offer should contain the offeror’s best terms from a cost or price technical standpoint.
- c. Price evaluation will be based on the total cost to the Authority for base year requirements plus optional requirements (if any).
- d. The technical items will be evaluated by an adjectival rating, a proposal risk rating, and a performance risk rating. The adjectival rating depicts how well the Offeror’s proposal meets the evaluation standards and solicitation requirements in the Technical Area. The proposal risk assesses the risks associated with the Offeror’s proposed approach as it relates to accomplishing the requirements of the Request for Proposal. Performance risk assesses the probability of the Offeror successfully accomplishing the proposed effort based on the Offeror’s demonstrated past and present performance.

22. PROPOSAL EVALUATION CRITERIA

The following evaluation factors will be used to evaluate proposals submitted in response to this solicitation. The evaluation factors are listed in descending order of importance with the most important factor listed first and the least important listed last:

- 22.1. Criterion I: Technical Solution** – The offeror must clearly demonstrate its understanding of the technical requirements. The offeror shall provide descriptive text beyond phrases such as “Read and understood” or “Offeror will comply,” where applicable.

The offeror shall demonstrate its expertise in enterprise hybrid cloud storage solutions for backup and recovery, and address all the requirements outlined in the statement of work. Specifically, the offeror should show two implementations in environments similar to the WMATA infrastructure implementing cloud based backup solutions.

- 22.2. Criterion II: Bench Strength** - The offeror shall provide offeror must demonstrate that it possesses the bench strength of qualified technicians with hands-on work experience with Storage vMotion Oracle, (TSM, Oracle RMAN, SQL) Backup, and allocation of iSCSI targets. Offeror acknowledges that WMATA may direct the offeror to remove any project staff that WMATA finds unacceptable, and the offeror shall immediately remove such staff (and replace with new staff satisfactory to WMATA within three days, if requested).

22.3. Criterion III: Business Organization and Reputation – Offeror must: provide the full name and address of its organization, including the parent company if it is a subsidiary; specify the branch office or other subordinate element that will perform or assist in performing the work herein; indicate whether it operates as a partnership, corporation, or individual; include the state in which it is incorporated or license to operate; and indicate the number of years the organization has been in existence. Additionally, offeror must list the company’s core competencies, including any appropriate certifications, and/or awards that the organization has received in the past three (3) years; indicate the number of years the organization has been performing the listed core competencies; and list the types and names of the organizations to which services have been provided.

23. RATINGS FOR PROPOSAL EVALUATION CRITERIA

Each criterion will be rated using the Adjectival scoring method as follows:

Definition of Adjective Rankings:

Acceptable	Meets evaluation standards required under the technical provisions. Weaknesses are correctable.
Marginal	Fails to meet evaluation standard; however any significant deficiencies are correctable. Lacks essential information to support a proposal.
Unacceptable	Fails to meet an acceptable evaluation standard and the deficiency is uncorrectable. Proposal would have to undergo a major revision to become acceptable. Demonstrated lack of understanding of WMATA’s requirements or omissions of major areas.

A rating of “Acceptable” is required to be eligible for award consideration. Offeror is cautioned to be aware of this standard when preparing your Proposal.

24. DEFINITIONS FOR TECHNICAL EVALUATION

Clarifications:	Communications with an offeror for the sole purpose of eliminating minor irregularities, informalities, or apparent clerical mistakes in the proposal. Unlike discussions, clarifications do not give the offeror an opportunity to revise or modify its proposal, except to the extent that correction of apparent clerical mistake results in revisions.
Discussions:	Oral or written communications including negotiations between the Authority and an offeror (other than clarifications) that; involves information essential for determining the acceptability of the proposal or to cure identified defects in the proposal.
Deficiencies:	Defects in the proposal which preclude acceptance. Involves any part of the Offeror’s proposal which would not satisfy the Authority’s minimum requirements established in the solicitation. Included failures to meet specifications, submit information, or questionable technical or management approaches. Items disclosed during discussions, evaluated in two categories: material-basis for rejection because further discussions

would be meaningless; curable –may be corrected by clarifications or discussions and brought into the competitive range.

Weakness: Includes ambiguities, lack of complete descriptions, errors in interpretation, omissions of essential information, inadequate information, all of which are considered curable in discussions. An excessive number of clarifications may in itself constitute a weakness.

Strengths: Elements of the proposal that meet or exceed the minimum requirements of the solicitation and provide an identified benefit to the Authority.

25. PRICE PROPOSAL EVALUATION

a. The Authority will evaluate price proposals for reasonableness, completeness, and realism as appropriate. Each Offeror's cost will be evaluated in terms of the following which are equal in importance:

- (1) Submittal of proposed prices for both the Base and the Options, if any, failure to do so will necessitate rejection of the proposal;
- (2) Any offer which is materially unbalanced may be rejected. An unbalanced offer is one which is based on prices that are significantly overstated for some items and understated for other items;
- (3) The Authority will compare the price proposals to the Authority estimate and otherwise determine reasonableness by performing a price analysis if adequate competition exists. A cost analysis will be performed if adequate price competition does not exist, to ascertain whether or not the proposed price is fair and reasonable; and
- (4) In accordance with FAR 15.804 3, the Offeror shall provide certified cost or pricing data as requested by the Contracting Officer.

26. TYPE OF CONTRACT

The Authority will award a **Firm-fixed-Price Contract**. The contractor will be required to submit Monthly Invoices to WMATA's Contracting Officer Technical Representative for payment approval.

27. ENGLISH LANGUAGE AND UNITED STATES CURRENCY

As regards this solicitation and the resultant contract:

- a. All communications (oral, written, electronic and otherwise including but, not limited to software coding) shall be in the English language.
- b. All pricing shall be in United States dollars.

28. FEDERAL/LOCAL/STATE SALES TAX

a. The Authority is exempt under this solicitation from all Federal, State and District of Columbia, municipal and local taxation.

- b. This provision supersedes any language pertaining to payment of taxes that may appear elsewhere in this solicitation.
- c. The Authority's tax exempt numbers are as follows: District of Columbia -- 5611-0082187-001; Maryland -- 30072210; Virginia -- 5280-0067.

29. BRAND NAME OR EQUAL

- a. If items called for by this Request for Proposal have been identified in the Schedule by a "brand name or equal" description, such identification is intended to be descriptive, but not restrictive, and is to indicate the quality and characteristics of products that will be satisfactory. Proposals offering "equal" products including products of the brand name manufacturer other than the one described by brand name will be considered for award if such products are clearly identified in the proposals and are determined by the Authority to meet fully the salient characteristics requirements in the Request for Proposals.
- b. Unless the Offeror clearly indicates in his proposal that he is offering an "equal" product, his proposal shall be considered as offering a brand name product referenced in the Request for Proposals.
- c. (1) If the Offeror proposes to furnish an "equal" product, the brand name, if any, of the product to be furnished in the space provided in the Request for Proposals, or such product shall be otherwise clearly identified in the proposal. The evaluation of proposals and the determination as to equality of the product offered shall be the responsibility of the Authority and will be based on information reasonable available to the Department of Procurement.

CAUTION TO OFFERORS. WMATA is not responsible for locating or securing any information which is not identified in the proposal and reasonably available to the Authority. Accordingly, to insure that sufficient information is available, the Offeror must furnish as a part of his proposal all descriptive material (such as cuts, illustrations, drawings, or other information) necessary for the Authority to (i) determine whether the product offered meets the salient characteristics requirements of the Request for Proposals and (ii) establish exactly what the offeror proposes to furnish and what the Authority would be binding itself to purchase by making an award. The information furnished may include specific references to information previously furnished or to information otherwise available to the Authority.

- (2) If the offeror proposes to modify a product so as to make it conform to the requirements of the Request for Proposals, he shall (i) include in his proposal a clear description of such proposed modifications, and (ii) clearly mark any descriptive material to show the proposed modifications.
- (3) Modifications proposed after proposal closing to make a product conform to a brand name product referenced in the Request for Proposal may not be considered.
 - (a) If an item in this solicitation is identified as "brand name or equal," the purchase description reflects the characteristics and level of quality that will satisfy the Government's needs. The salient physical, functional, or performance characteristics that "equal" products must meet are specified in the solicitation.

- (b) To be considered for award, offers of “equal” products, including “equal” products of the brand name manufacturer, must—
- (1) Meet the salient physical, functional, or performance characteristic specified in this solicitation;
 - (2) Clearly identify the item by—
 - (i) Brand name, if any; and
 - (ii) Make or model number;
 - (3) Include descriptive literature such as illustrations, drawings, or a clear reference to previously furnished descriptive data or information available to the Contracting Officer; and
 - (4) Clearly describe any modifications the offeror plans to make in a product to make it conform to the solicitation requirements. Mark any descriptive material to clearly show the modifications.
- (c) The Contracting Officer will evaluate “equal” products on the basis of information furnished by the offeror or identified in the offer and reasonably available to the Contracting Officer. The Contracting Officer is not responsible for locating or obtaining any information not identified in the offer.
- (d) Unless the offeror clearly indicates in its offer that the product being offered is an “equal” product, the offeror shall provide the brand name product referenced in the solicitation.

**REPRESENTATIONS AND CERTIFICATIONS
(FEDERALLY FUNDED SUPPLY/SERVICE/CONSTRUCTION CONTRACTS)**

REPRESENTATIONS

Instructions: Check or complete all applicable boxes or blocks on this form and submit it with your offer.

1. TYPE OF BUSINESS ORGANIZATION

By submission of this offer, the offeror represents that it operates as an individual, a partnership, a limited liability company, a joint venture, a nonprofit organization, or a corporation, incorporated under the laws of the State of _____.

2. AFFILIATION AND IDENTIFYING DATA

Each offeror shall complete (a), (b) if applicable, and (c) below, representing that:

(a) It is, is not, owned or controlled by a parent company. For this purpose, a parent company is defined as one which either owns or controls the activities and basic business policies of the offeror. To own another company means the parent company must own at least a majority, i.e., more than 50 percent, of the voting rights in that company. To control another company, such ownership is not required; if another company is able to formulate, determine or veto basic business policy decisions of the offeror, such other company is considered the parent of the offeror. This control may be exercised through the use of dominant minority voting rights, use of proxy voting, contractual arrangements or otherwise.

(b) If the offeror is owned or controlled by a parent company, it shall insert in the space below the name and main office address of the parent company:

Name of Parent Company

Main Office Address (including ZIP Code)

(c) If the offeror has no parent company, it shall provide in the applicable space below its own Employer's Identification Number (E.I.N.), (i.e., number used on Federal Tax Returns or, if it has a parent company, the E.I. No. of its parent company).

Offeror E.I. Number: _____ or, Parent Company's E.I. Number: _____

(d) If a Data Universal Numbering Systems (DUNS), number has not been established for the address entered on the Solicitation, Offer, and Award Form, the Authority will arrange for the assignment of this number after award of a contract and will notify the Contractor accordingly.

3. PREVIOUS CONTRACTS AND COMPLIANCE REPORTS

This representation is applicable to federally assisted contracts. By submission of this offer, the offeror represents that:

(a) It has, has not, participated in a previous contract or subcontract subject to either the Equal Opportunity Clause of this solicitation, or the clause contained in Parts II and IV of Executive Order 11246, as amended; which prohibits discrimination on the basis of race, color, creed, national origin, sex, age; and

- (b) It has, has not, filed all required compliance reports; and
- (c) Representations indicating submittal of required compliance reports signed by proposed subcontractors will be obtained prior to subcontract awards.

4. DISADVANTAGED BUSINESS ENTERPRISE

This representation is applicable to federally assisted contracts. By submission of this offer, the offeror represents that:

- (a) It is, is not, a disadvantaged business enterprise.

"Disadvantaged Business Enterprise" means a for-profit small business concern that is at least 51% owned by one or more individuals who are both socially and economically disadvantaged individuals or, in the case of a corporation, in which 51% of the stock is owned by one or more such individuals; and whose management and daily business operations are controlled by one or more socially and economically disadvantaged individuals who own it.

"Socially and Economically Disadvantaged Individuals" is defined in Appendix B, Section 4, paragraph I; and

- (b) It is, is not, currently certified by WMATA as a disadvantaged business enterprise.

5. AFFIRMATIVE ACTION COMPLIANCE

This representation is applicable to federally assisted contracts of \$50,000 or more that are awarded to contractors with 50 or more employees. By submission of this offer, the offeror represents that:

- (a) It has a workforce of _____ employees.
- (b) It has developed and has on file, or has not developed and does not have on file, at each establishment, affirmative action programs required by the rules and regulations of the Secretary of Labor (41 CFR Parts 60-1 and 60-2), or
- (c) It has not previously had contracts subject to the written affirmative action program requirements of the rules and regulations of the Secretary of Labor.

CERTIFICATIONS

6. COVENANT AGAINST GRATUITIES

By submission of this offer, the offeror certifies, and in the case of a joint offer, each party thereto certifies as to its own organization, that in connection with this procurement:

Neither it nor any of its employees, representatives or agents have offered or given gratuities (in the form of entertainment, gifts or otherwise) to any director, officer or employee of the Authority with the view toward securing favorable treatment in the awarding, amending, or the making of any determination with respect to the performing of the contract.

7. CONTINGENT FEE

By submission of this offer, the offeror certifies, and in the case of a joint offer, each party thereto certifies as to its own organization, that in connection with this procurement:

- (a) It [] has, [] has not, employed or retained any company or persons (other than a full-time, bona fide employee working solely for the offeror) to solicit or secure this contract, and
- (b) It [] has, [] has not, paid or agreed to pay any company or person (other than a full-time, bona fide employee working solely for the offeror) any fee, commission, percentage, or brokerage fee contingent upon or resulting from the award of this contract.

8. CLEAN AIR AND WATER CERTIFICATION

This certification is applicable if the contract will be federally assisted and the offer exceeds \$100,000, or the Contracting Officer believes that orders under an indefinite contract in any year will exceed \$100,000 or a facility to be used has been the subject of a conviction under the Clean Air Act (42 U.S.C. 7413(c)(1)) or the Water Act (33 U.S.C. 1319(c)) and is listed by the U.S. Environmental Protection Agency (EPA) as a violating facility, and the acquisition is not otherwise exempt:

- (a) Any facility to be utilized in the performance of this proposed contract [] is, or [] is not listed on the EPA list of Violating Facilities;
- (b) Offeror will immediately notify the Contracting Officer, before award, of the receipt of any communications from the Administrator, or a designee of the EPA, indicating that any facility which it proposes to use for the performance of the contract is under consideration to be listed on the EPA List of Violating Facilities; and
- (c) Offeror will include a certification substantially the same as this certification, including this paragraph, in every non-exempt subcontract.

9. DEBARMENT, SUSPENSION, INELIGIBILITY, AND VOLUNANTARY EXLCUSION

This certification is applicable to federally assisted contracts over \$25,000.

- (a) Primary Covered Transactions. This certification applies to the offer submitted in response to this solicitation and will be a continuing requirement throughout the term of any resultant contract.
 - (1) In accordance with the provisions of Appendix A to 49 Code of Federal Regulations (CFR) Part 29, the offeror certifies to the best of its knowledge and belief that it and its principals:
 - (i) are not currently debarred, suspended, proposed for debarment, declared ineligible, or voluntarily excluded from covered transactions by any Federal or State department or agency;
 - (ii) have not, within a three-year period preceding this offer, been convicted of or had a civil judgment rendered against them for commission of fraud or a criminal offense in connection with obtaining, attempting to obtain, or performing a public (Federal, State, or local) transaction or contract under a public transaction; violation of Federal or State antitrust statutes, or commission of embezzlement, theft, forgery, bribery, falsification or destruction of records, making false statements, or receiving stolen property;
 - (iii) are not currently indicted for or otherwise criminally or civilly charged by a governmental entity (Federal, State, or local) with commission of any of the offenses enumerated in paragraph (1)(ii) of this Certification; and
 - (iv) have not, within a three-year period preceding this offer, had one or more public transactions (Federal, State, or local) terminated for cause or default.

- (2) Where the offeror is unable to certify to any of the statements in this certification, the offeror shall attach an explanation to this offer.

- (b) Lower Tier Covered Transactions. This certification applies to a subcontract at any tier expected to equal or exceed \$25,000 and will be a continuing requirement throughout the term of the prime contract.
 - (1) In accordance with the provisions of Appendix B to 49 Code of Federal Regulations (CFR) Part 29, the prospective lower tier subcontractor certifies, by submission of this offer, that neither it nor its principals is currently debarred, suspended, proposed for debarment, declared ineligible, or voluntarily excluded from participation in this transaction by any Federal or State department or agency.

 - (2) Where the prospective lower tier subcontractor is unable to certify to any of the statements in this certification, such prospective participant shall attach an explanation to this proposal.

- (c) The Certification required by subparagraph (b), above, shall be included in all applicable subcontracts and a copy kept on file by the prime contractor. The prime contractor shall be required to furnish copies of certifications to the Contracting Officer upon the Contracting Officer's request.

10. CERTIFICATION OF INDEPENDENT PRICE DETERMINATION

- (a) By submission of this offer, the offeror certifies, and in the case of a joint offer, each party thereto certifies as to its own organization, that in connection with this procurement:
 - (1) The prices in this offer have been arrived at independently, without, for the purpose of restricting competition, any consultation, communication, or agreement with any other offeror or with any other competitor, as to any matter relating to such prices;

 - (2) Unless otherwise required by law, the prices which have been quoted in this offer have not been knowingly disclosed by the offeror and will not be knowingly disclosed by the offeror prior to award (in the case of a negotiated procurement), directly or indirectly, to any other offeror or to any competitor; and

 - (3) No attempt has been made or will be made by the offeror to induce any other person or firm to submit or not to submit an offer for the purpose of restricting competition.

- (b) Each person signing this offer certifies that:
 - (1) He or she is the person in the offeror's organization responsible within that organization for the decision as to the prices being offered herein and that he/she has not participated, and will not participate, in any action contrary to (a)(1) through (a)(3) above; or

 - (2) He or she is not the person in the offeror's organization responsible within that organization for the decision as to the prices being offered herein, but that he/she has been authorized in writing to act as agent for the persons responsible for such decision in certifying that such persons have not participated; and will not participate, in any action contrary to (a)(1) through (a)(3) above, and as their agent does hereby so certify.

11. CERTIFICATION OF NONSEGREGATED FACILITIES

This certification is applicable to federally assisted contracts over \$10,000.

- (a) By submission of this offer, the offeror certifies, and in the case of a joint offer, each party thereto certifies as to its own organization, that in connection with this procurement:
 - (1) It does not and will not maintain or provide for its employees any segregated facilities at any of its establishments, and that it does not and will not permit its employees to perform their services at any location under its control, where segregated facilities are maintained.
 - (2) The offeror agrees that a breach of this certification is a violation of the Equal Opportunity Clause in the contract.
 - (3) As used in this certification, the term "segregated facilities" means any waiting rooms, work areas, rest rooms and wash rooms, restaurants and other eating areas, time clocks, locker rooms and other storage or dressing areas, parking lots, drinking fountains, recreation or entertainment areas, transportation, and housing facilities provided for employees which are segregated by explicit directive or are in fact segregated on the basis of race, color, religion or national origin, because of habit, local custom or otherwise.
 - (4) It further agrees that (except where it has obtained identical certifications from proposed subcontractors for specific time periods) it will:
 - (a) Obtain identical certifications from proposed subcontractors before the award of subcontracts under which the subcontractor will be subject to the Equal Opportunity clause;
 - (b) Retain such certifications in its files; and
 - (c) Forward the following notice to such subcontractors (except if the proposed subcontractors have submitted identical certifications for specific time periods):

NOTICE TO PROSPECTIVE SUBCONTRACTORS OF REQUIREMENTS FOR CERTIFICATIONS OF NONSEGREGATED FACILITIES

A Certification of Nonsegregated Facilities must be submitted prior to award of a subcontract exceeding \$10,000 which is not exempt from the provisions of the Equal Opportunity clause. The certification may be submitted either for such subcontract or for all subcontracts during a period (i.e., quarterly, semiannually or annually).

12. NONDISCRIMINATION ASSURANCE

By submission of this offer, the offeror certifies, and in the case of a joint offer, each party thereto certifies as to its own organization, in connection with this procurement that it will not discriminate on the basis of race, color, creed, national origin, sex, age in the performance of this contract. The offeror is required to insert the substance of this clause in all subcontracts and purchase orders. Failure by the contractor to carry out these requirements is a material breach of this contract, which may result in the termination of this contract or such other remedy as the Authority deems appropriate. The offeror further agrees by submitting this offer that it will include this certification, without modification, in all subcontracts and purchase orders.

13. CERTIFICATION OF RESTRICTIONS ON LOBBYING

This certification is applicable to federally assisted contracts if the offer exceeds \$100,000.

- (a) By submission of this offer, the offeror certifies, and in the case of a joint offer, each party thereto certifies as to its own organization, that to the best of his or her knowledge or belief:

- (1) No Federal appropriated funds have been paid or will be paid, by or on behalf of the undersigned, to any person for influencing or attempting to influence an officer or employee of an agency, a Member of Congress, an officer or employee of Congress, or an employee of a Member of Congress in connection with the awarding of any Federal contract, the making of any Federal grant, the making of any Federal loan, the entering into of any cooperative agreement, and the extension, continuation, renewal, amendment, or modification of any Federal contract, grant, loan, or cooperative agreement.
 - (2) If any funds other than Federal appropriated funds have been paid or will be paid to any person for making lobbying contacts to an officer or employee of any agency, a Member of Congress, an officer or employee of Congress, or an employee of a Member of Congress in connection with this contract, the undersigned shall complete and submit Standard Form--LLL, "Disclosure of Lobbying Activities."
 - (3) The undersigned shall require that the language of this certification be included in the award documents for all subawards at all tiers and that all subrecipients shall certify and disclose accordingly.
- (b) This certification is a material representation of fact upon which reliance was placed when this transaction was made or entered into. Submission of this certification is a prerequisite for making or entering into this transaction imposed by 31 U.S.C. § 1352, as amended. Any person who fails to file the required certification shall be subject to a civil penalty of not less than \$10,000 and not more than \$100,000 for each such failure.

14. BUY AMERICA ACT CERTIFICATION

The Buy America requirements apply to federally assisted construction contracts, and acquisition of goods or rolling stock contracts valued at more than \$100,000.

- (a) By submission of this offer, the offeror certifies, and in the case of a joint offer, each party thereto certifies as to its own organization, that in connection with this procurement it will comply with 49 U.S.C. 5323(j) and 49 C.F.R. Part 661, which provide that Federal funds may not be obligated unless steel, iron, and manufactured products used in FTA-funded projects are produced in the United States, unless a waiver has been granted by FTA or the product is subject to a general waiver. General waivers are listed in 49 C.F.R. 661.7 Separate requirements for rolling stock are set out at 49 U.S.C. 5323(j)(2)(C) and 49 C.F.R. 661.11.
- (b) An offeror must submit to the Authority the appropriate Buy America certification (below) with all offers on FTA-funded contracts, except those subject to a general waiver. Offers that are not accompanied by a completed Buy America certification must be rejected as nonresponsive. This requirement does not apply to lower tier subcontractors. Mark the applicable certifications below:
 - (1) **Certification requirement for procurement of steel, iron, or manufactured products:**
 - Certificate of Compliance with 49 U.S.C. 5323(j)(1)*
The offeror hereby certifies that it will meet the requirements of 49 U.S.C. 5323(j)(1) and the applicable regulations in 49 CFR Part 661.5.
 - Certificate of Non-Compliance with 49 U.S.C. 5323(j)(1)*
The offeror hereby certifies that it cannot comply with the requirements of 49 U.S.C. 5323(j)(1) and 49 C.F.R. 661.5, but it may qualify for an exception pursuant to 49 U.S.C. 5323(j)(2)(A), 5323(j)(2)(B), or 5323(j)(2)(D), and 49 C.F.R. 661.7.

(2) **Certification requirement for procurement of buses, other rolling stock and associated equipment:**

Certificate of Compliance with 49 U.S.C. 5323(j)(2)(C)

The offeror hereby certifies that it will comply with the requirements of 49 U.S.C. 5323(j)(2)(C) and the regulations at 49 C.F.R. Part 661.11.

Certificate of Non-Compliance with 49 U.S.C. 5323(j)(2)(C)

The offeror hereby certifies that it cannot comply with the requirements of 49 U.S.C. 5323(j)(2)(C) and 49 C.F.R. 661.11, but may qualify for an exception pursuant to 49 U.S.C. 5323(j)(2)(A), 5323(j)(2)(B), or 5323(j)(2)(D), and 49 C.F.R. 661.7.

15. CERTIFICATION OF NON-DELINQUENT TAXES

This certification is applicable to federally assisted contracts.

(a) By submission of this offer, the offeror certifies, and in the case of a joint offer, each party thereto certifies as to its own organization, that in connection with this procurement:

(1) It has not been convicted over the past three years of violating any federal criminal tax law or failed to pay any tax.

(2) It has certified if it has been notified of an unresolved tax lien or any unsatisfied federal tax delinquency in excess of \$3,000 and that it is paying tax debts through an installment agreement or have requested a collection due process hearing.

(3) The offeror agrees that a breach of this certification is a violation of the Federal Acquisition Regulation.

(4) As used in this certification, the term "tax delinquency" means an outstanding debt for which a notice of lien has been filed in public records.

(5) It further agrees that (except where it has obtained identical certifications from proposed subcontractors for specific time periods) it will:

(b) Obtain identical certifications from proposed subcontractors before the award of subcontracts under which the subcontractor will be subject to Federal Acquisition Regulation;

(c) Retain such certifications in its files; and

(d) Forward the following notice to such subcontractors (except if the proposed subcontractors have submitted identical certifications for specific time periods):

**NOTICE TO PROSPECTIVE SUBCONTRACTORS OF REQUIREMENTS FOR CERTIFICATION
 OF NON-DELINQUENT TAXES**

A Certification of Non-Delinquent Taxes must be submitted prior to award of a subcontract exceeding \$100,000 which is not exempt from the provisions of Federal Acquisition Regulation. The certification may be submitted either for such subcontract or for all subcontracts during a period (i.e., quarterly, semiannually or annually). (RC-116, OCTOBER 08)

16. DISCLOSURES OF INTERESTS OF WMATA BOARD MEMBERS

For purposes of this disclosure, terms in bold are defined by the Code of Ethics for Members of the WMATA Board of Directors a copy of which is available at www.wmata.com. Financial interest includes ownership interests and prospective and actual income. Firm includes parents, subsidiaries and affiliates.

By submission of this offer, the offeror certifies, and in the case of a joint offer, each party thereto certifies as to its own organization, that to the best of your knowledge, information and belief in connection with this procurement:

- (a) No WMATA **Board Member, Household Member or Business Associate** has a financial interest in this firm, in a **Financial Transaction** with the Authority to which this firm is a party or prospective party, or in an **Actual or Prospective Business Relationship with the Authority** to which this firm is a party.

- (b) The following WMATA **Board Member(s), Household Member(s) or Business Associate(s)** has a financial interest in this firm, in a **Financial Transaction** with the Authority to which this firm is a party or prospective party, or in an **Actual or Prospective Business Relationship with the Authority** to which this firm is a party, Include in Nature of Interest below a description of the financial interest and (1) for ownership interests, the value of the interest, the name and address of the firm in which the interest is held, and the total equity or equivalent interest of the firm; and (2) for income, the amount of all income received by the **Board Member, Household Member or Business Associate** in the current and preceding fiscal year for services provided, and the name and address of the firm from which the income was received.

Name of Board Member Household Member or Business Associate	Nature of Interest

- (c) The certification required by subparagraphs (a) and (b) above shall be included in all subcontracts. The prime contractor shall furnish copies of certifications to the contracting officer and retain a copy for inspection upon the contracting officer's request.

SIGNATURE BLOCK FOR ALL REPRESENTATIONS AND CERTIFICATIONS

Name of Offeror: _____

Name and Title of Authorized
Representative: _____

Print and Sign Name

Title

Date

PRE-AWARD EVALUATION DATA

PROJECT DESCRIPTION: _____

1. Name of Firm _____

2. Address: _____

3. Individual Partnership Corporation Joint Venture

4. Date Organized _____.

State in which incorporated _____.

5. Names of Officers or Partners:

a. _____

b. _____

c. _____

d. _____

e. _____

f. _____

6. How long has your firm been in business under its present name?

7. Attach as SCHEDULE ONE a list of similar current contracts which demonstrates your technical proficiency, each with contract amount, name of contracting party, character or type of work and percentage of completion.

8. Attach as SCHEDULE TWO a list of similar contracts, each with contract amount, name of contracting party, and character or type of work for similar contracts completed in the last two years.

9. In the last two years have you ever been denied an award where you were the offeror?

If the answer is YES, attach as SCHEDULE THREE the full particulars regarding each occurrence.

10. Have you ever failed to complete, in the last two years, any contract on which you were the offeror?

If the answer is YES, attach as SCHEDULE FOUR, the full particulars regarding each occurrence.

11. Financial resources available as working capital for the Contract:

a. Cash on hand: \$ _____

- b. Sources of credit: _____
12. Attach as SCHEDULE FIVE financial statements and letters from banks regarding credit as required by the Pre-Award Information article.
 13. What percentage of work (contract amount) do you intend performing with your own personnel? %.
 14. Attach as SCHEDULE SIX a list of all principal subcontractors and the percentage and character of work (contract amount) which each will perform. Principal items of work shall include, but not be limited to, those items listed in the Pre-Award Information article of the Request for Proposal.
 15. If the Contractor or subcontractor is a joint venture, submit PRE-AWARD EVALUATION DATA forms for each member of the joint venture.

The above information is confidential and will not be divulged to any unauthorized personnel.

The undersigned certifies to the accuracy of all information.

COMPANY: _____
SIGNATURE: _____
NAME: _____
TITLE: _____
DATE: _____

PART II – GENERAL / SPECIAL PROVISIONS

PART II – SECTION 1 - GENERAL PROVISIONS

PART II, SECTION 1 - GENERAL PROVISIONS

1. DEFINITIONS

As used throughout this Contract, the following terms shall have the meanings set forth below:

- a. "Authority" means The Washington Metropolitan Area Transit Authority created effective February 20, 1967, by Interstate Compact by and between Maryland, Virginia, and the District of Columbia, pursuant to Public Law 89-774, approved November 6, 1966.
- b. "Authority Representative" if designated, is the person responsible for post award execution of an Authority contract in the most effective, economical, and timely manner. The Authority Representative is the Authority's primary point of contact with its Contractor. In addition, the Authority Representative is delegated authority to modify this Contract within specified dollar limits which are available upon request. The Authority may designate additional individuals, usually in the supervisory chain as the Authority Representative, who have dollar authority in excess of the Authority Representative's stated authority (see also definition of Contracting Officer). The Authority Representative may, at his or her discretion, delegate Project responsibilities to a Project Representative and certain other responsibilities to other designees. Unless the Contractor is directed to the contrary, all correspondence with respect to this Contract shall be sent to the Authority Representative.
- c. "Contracting Officer" means an employee within the Authority's Office of Procurement and Materials with authority duly delegated from the powers of the General Manager to legally bind the Authority by signing a contractual instrument. Contracting Officers have the authority to make related determinations and findings, and take other significant actions including, but not limited to: awards, changes, modifications, final payments, suspensions, terminations, debarments, assessment of liquidated damages, and issuances of final decisions. The term includes certain other representatives of the Authority acting within delegated limits of authority. In general, the Authority's primary point of contact for pre-award administration and fiscal closeout resides with the Contracting Officer, and the primary point of contact for the post-award contract administration may be either the Authority Representative or Contracting Officer's Technical Representative.
- d. "Contracting Officer's Technical Representative (COTR)" means a duly appointed individual assigned to perform contract administration activities as may be specifically authorized in regard to technical issues. A COTR does not have the authority to enter into contractual agreements including changes or modifications.
- e. "FTA" means the U.S. Department of Transportation, Federal Transit Administration.
- f. "Project Representative" means the individual(s), including but not limited to the Resident Engineer, to whom the Authority Representative has delegated Project responsibilities. If a Project Representative is appointed, the Project Representative represents the Authority Representative on the Project within the limits of that delegation with respect to any part of the Work.

- g. Except as otherwise provided in this Contract, the term subcontracts includes purchase orders under this Contract.
- h. Wherever in the scope of the work the words directed, ordered, designated, prescribed, or words of like import are used, it shall be understood that the direction, requirement, order, designation, or prescription of the Contracting Officer is intended and similarly the words approved, acceptable, satisfactory, or words of like import shall mean approved by, or acceptable to, or satisfactory to the Contracting Officer, unless otherwise expressly stated.

2. ACCOUNTING AND RECORD KEEPING

- a. **Applicability.** This Article shall become effective for and shall apply to any adjustment in the price of this Contract initiated by the Contractor or the Authority. However, where the original amount of this Contract is less than \$1,000,000, paragraph c. of this Article does not apply unless the adjustment is expected to exceed \$50,000.
- b. **Forward Priced Adjustments.** Unless expressly waived in writing in advance by the Contracting Officer, the Contractor shall furnish to the Contracting Officer a cost proposal in advance of performance of any work for which a price adjustment is requested under this Contract. The proposal format shall be as detailed in Article 39. The Contractor shall originate such records as are necessary to substantiate all elements of the pricing proposal, current to the date of agreement on the pricing adjustment. Such records supporting the costs of each pricing adjustment request shall be specifically segregated and identified in the Contractor's accounting system as being applicable to the pricing adjustment request.
- c. **Post Pricing Adjustments.** In addition to the records required to be originated under b. above, in the event pricing of an adjustment under this Contract is not agreed upon between the Contractor and the Contracting Officer prior to the commencement of work for which the pricing adjustment is requested, the Contractor and any subcontractor engaged in work for which the pricing adjustment is requested, shall maintain accounts and original cost records specifically segregated and identified by job order or other appropriate accounting procedures approved by the Contracting Officer of all incurred segregable costs related to the work for which the pricing adjustment is requested. The Contractor shall maintain accounts and records which segregate and account for the costs of all work associated with that part of the project for which the pricing adjustment is requested and shall allocate the costs so accumulated between (1) work required under the base Contract; (2) work requested to be reimbursed under the pricing adjustment; and (3) other claim, including but not limited to, changes, differing site conditions, and the like. The accounts and records so established shall accumulate such costs under logical costs groups, such as material, labor, equipment, subcontracts, field overhead and the like. The Contractor shall record these costs on a form approved by the Contracting Officer. Subject to agreement between the Contractor and the Contracting Officer, or upon direction of the Contracting Officer for work under Article 58, the Contractor shall use Form C-113 (Daily Report - Labor Materials and Equipment). The terms of Article 58.d of this Contract shall apply regardless of the form used.
- d. **Availability.** The accounts, records and costs information required to be originated under b. and c. above together with all other accounts, records and costs information related to this Contract shall be maintained and made available by the Contractor and subcontractor(s).

- (1) At the office of the Contractor or subcontractor(s) at all reasonable times for inspection, audit, reproduction or such other purposes as may be required by the Contracting Officer or by anyone authorized access to the records by the Contracting Officer or pursuant to any other provisions of this Contract.
 - (2) Until the expiration of three years from the date of payment of the final \$100 (final payment) under this Contract or such lesser time as is specified in Subpart 4.7 of the Federal Acquisition Regulations and for such longer period, if any, as is required by applicable statute, or by other articles of this contract, or by paragraphs (a) and (b) below:
 - (a) If the Contract is completely or partially terminated, for a period of three years from either the date of any resulting final settlement or the date of final payment whichever is the greater period; and
 - (b) If a pricing adjustment is involved in any appeal under the Disputes Article of this Contract or in any litigation related to this Contract, for a period of one (1) year following the final disposition of the appeal or litigation.
- e. When asserting a claim under the various provisions of this Contract, the Contractor shall grant the Authority access to review and ascertain the validity of the accounting records being maintained for segregation of costs, including base cost records, and to audit such costs as are deemed appropriate by the Contracting Officer. No payment shall be made to the Contractor on its claim until such records are made available and access is permitted.
- f. Limitation on Pricing Adjustment. In the event the Contractor or any subcontractor fails to originate or to maintain, or to make available any accounts or records as required under this or any other Article of the Contract, any pricing adjustment or portion thereof previously granted by the Contracting Officer for which records are not available shall be rescinded and recomputed, or if a pricing adjustment has not yet been granted shall be computed, in an amount not to exceed the direct costs for the affected work for which accounts or records are not available, plus a single mark-up for indirect expenses not to exceed ten percent of the direct costs so determined by the Contracting Officer. The adjustment will be established by the Contracting Officer based upon, at his or her election, either,
- (1) an audit of any existing books and records of the Contractor or subcontractor; or
 - (2) an Authority estimate adopted by the Contracting Officer, or
 - (3) a combination of (1) and (2);
- plus a single mark-up for indirect expenses not to exceed ten percent of the direct costs so determined by the Contracting Officer. The Contractor and subcontractors shall not be allowed any profit for the work for which the Contractor or subcontractor fails to originate, or to maintain, or to make available any accounts or records as required under this Contract.
- g. The Contractor shall insert a clause containing all the provisions of this article in all subcontracts issued under this Contract, modified as necessary, for proper

identification of the contracting parties and the Contracting Officer under this Contract.

3. ASSIGNMENT

- a. Except as otherwise provided in this provision, the Contractor shall not transfer any of its rights and obligations under this Contract to third parties without the prior consent of the Authority. The Authority may recognize a third party as successor in interest to the Contract in the event of a transfer of all or substantially all of the assets of the Contractor, a Division of the Contractor involved in the performance of the Contract, or a Parent company providing a performance guarantee under this Contract, (i.e., sales of assets, transfer of assets pursuant to merger or consolidation, or incorporation of a proprietorship or partnership). Such recognition of the transfer shall be within the discretion of the Contracting Officer after review of the facts and circumstances surrounding each request. At the discretion of the Contracting Officer, the Contracting Officer may conduct an evaluation of the successor party's capability to perform the Contract in the same manner and to the same extent the Contracting Officer was empowered to conduct a responsibility determination as part of the original solicitation for this Contract. Should the Contracting Officer, for any reason, not recognize such a successor in interest, it may terminate this Contract for the convenience of the Authority.
- b. Claims for monies due or to become due the Contractor from the Authority under this Contract may be assigned to a bank, trust company, or other financing institution, including any Federal lending agency, and may thereafter be further assigned and reassigned to any institution, upon written notice of such assignment to the Authority. Any such assignment or reassignment shall cover all amounts payable under this Contract and not already paid, and shall not be made to more than one party, except that any such assignment or reassignment may be made to one party as agent or trustee for two or more parties participating in such financing. It is the Authority's intent to recognize assignments only to bona fide lending institutions; therefore, assignment to any private corporation, business or individual which does not qualify as such is specifically prohibited.
- c. Any attempt to transfer by assignment not authorized by this provision shall constitute a breach of the Contract and the Authority may for such cause, terminate the Contract with the DEFAULT provision of these General Provisions, and the Contractor shall be liable to the Authority under the DEFAULT provision.

4. AUDIT RECORDS-NEGOTIATION

- a. This clause is applicable if this Contract was entered into by means of negotiation and shall become operative with respect to any modification to this Contract whether this Contract was initially entered into by means of negotiation or by means of formal advertising.
- b. As used in this clause, "records" includes books, documents, accounting procedures and practices, and other data, regardless of type and regardless of whether such items are in written form, in the form of computer data, or in any other form.
- c. If this is a cost-reimbursement, incentive, time-and-materials, labor-hour, or price redeterminable contract, or any combination of these, the Contractor shall maintain and the Contracting Officer, or an authorized representative of the Contracting

Officer, shall have the right to examine and audit all records and other evidence sufficient to reflect properly all costs claimed to have been incurred or anticipated to be incurred directly or indirectly in performance of this contract. This right of examination shall include inspection at all reasonable times of the Contractor's plants, or parts of them, engaged in performing this contract.

- d. If the Contractor has been required to submit cost or pricing data in connection with any pricing action relating to this contract, the Contracting Officer, or an authorized representative of the Contracting Officer, in order to evaluate the accuracy, completeness, and currency of the cost or pricing data, shall have the right to examine and audit all of the Contractor's records, including computations and projections, related to the proposal for the contract, subcontract, or modification; the discussions conducted on the proposal(s), including those related to negotiating; pricing of the contract, subcontract or modification; or performance of the contract, subcontract or modification.
- e. If the Contractor is required to furnish cost, funding, or performance reports, the Contracting Officer or an authorized representative of the Contracting Officer shall have the right to examine and audit the supporting records and materials, for the purpose of evaluating the effectiveness of the Contractor's policies and procedures to produce data compatible with the objectives of these reports; and the data reported.
- f. The Contractor shall make available at its offices at all reasonable times the records, materials, and other evidence described above, for examination, audit or reproduction, until 3 years after final payment under this contract or for any shorter period specified in Subpart 4.7, Contractor Records Retention, of the Federal Acquisition Regulation (FAR), or for any longer period required by statute or by other clauses of this contract. In addition—
 - (1) If this contract is completely or partially terminated, the Contractor shall make available the records relating to the work terminated until 3 years after any resulting final termination settlement; and
 - (2) The Contractor shall make available records relating to appeals under the Disputes clause or to litigation or the settlement of claims arising under or relating to this contract until such appeals, litigation, or claims are fully resolved.
- g. The Contractor shall insert a clause containing all the terms of this clause, including this paragraph (g), in all subcontracts under this contract that exceed the simplified acquisition threshold (currently \$100,000 or less) and –
 - (1) That are cost reimbursable, incentive, time-and-material, labor-hour, or price redeterminable type or any combination of these;
 - (2) For which cost or pricing data are required; or
 - (3) That require the contractor to submit reports as discussed in paragraph (e) of this clause.

5. CERTIFICATE OF CURRENT COST OR PRICING DATA

The Contractor shall provide a Certificate of Current Cost or Pricing Data as required in Subpart 15.4 of the Federal Acquisition Regulations (48 CFR 15.4) in support of any negotiated contract expected to exceed \$100,000 any modification to a formally advertised or negotiated contract on which the aggregate of the increase and decreases in cost are expected to exceed \$100,000; the Contracting Officer at his discretion may request cost or pricing data for modifications on which cost are \$100,000 or less and an attendant certificate of current cost or pricing data.

6. CHANGES

- a. The Contracting Officer may at any time, by a written order, and without notice to the sureties, make changes, within the general scope of this Contract, in any one or more of the following:
 - (1) Description of services to be performed.
 - (2) Time of performance (i.e., hours of the day, days of the week, etc.).
 - (3) Place of performance of the services.
 - (4) Drawings, designs, or specifications, where the supplies to be furnished are to be specially manufactured for the Authority, in accordance with the drawings, designs, or specifications.
 - (5) Method of shipment or packing of supplies.
 - (6) Place of delivery.
- b. If any such change causes an increase or decrease in the cost of, or the time required for, the performance of any part of the work under this Contract, whether changed or not changed by the order, the Contracting Officer shall make an equitable adjustment in the Contract price, the delivery schedule, or both, and shall modify the Contract.
- c. The Contractor must assert its right to an adjustment under this article within 30 days from the date of receipt of the written order. Any such adjustment to the contract price must be agreed upon prior to final payment of the contract price.
- d. If the Contractor's proposal includes the cost of property made obsolete or excess by the change, the Contracting Officer shall have the right to prescribe the manner of the disposition of the property.
- e. Failure to agree to any adjustment shall be a dispute under the Disputes article. However, nothing in this article shall excuse the Contractor from proceeding with the contract as changed.

7. NONDISCRIMINATION ASSURANCE

- a. Nondiscrimination Assurance: In accordance with Title VI of the Civil Rights Act, as amended, 42 U.S.C. §2000d, section 303 of the Age Discrimination Act of 1975, as amended, 42 U.S.C. §6102, section 202 of the American with

Disabilities Act of 1990, 42 U.S.C. §12132, and Federal transit law at 49 U.S.C. §5332, the contractor, sub-recipient, or subcontractor agrees that it will not discriminate against any employee or applicant for employment because of race, color, creed, national origin, sex, age, or disability. In addition, the contractor, sub-recipient, or subcontractor agrees to comply with applicable Federal implementing regulations and other implementing regulations that FTA may issue.

b. Equal Employment Opportunity: The following equal employment opportunity requirements apply to this contract.

- (1) Race, Color, Creed, National Origin, Sex: In accordance with Title VII of the Civil Rights Act, as amended, 42 U.S.C. §2000e, and Federal transit laws at 49 U.S.C. §5332, the Contractor agrees to comply with all applicable equal opportunity requirements of the U. S. Department of Labor (U.S. DOL) regulations, "Office of Federal Contract Compliance Programs, Equal Employment Opportunity, Department of Labor, " 41 C.F.R. Parts 60 et seq., (which implement Executive Order No. 11246, "Equal Employment Opportunity," as amended by Executive Order No. 11375, "Amending Executive Order 11246 Relating to Equal Employment Opportunity," 42 U.S.C. 2000e note), and with any applicable Federal statutes, executive orders, regulations, and Federal policies that may in the future affect construction activities undertaken in the course of the Contract. The Contractor agrees to take affirmative action to ensure that applicants are employed, and that employees are treated during employment without regard to their race, color, creed, national origin, sex or age. Such action shall include, but not be limited to, the following: employment, upgrading, demotion or transfer, recruitment or recruitment advertising, layoff or termination; rates of pay or other forms of compensation; and selection for training, including apprenticeship. In addition, the Contractor agrees to comply with any implementing requirements FTA may issue.
- (2) Age: In accordance with Section 4 of the Age Discrimination in Employment Act of 1967, as amended, 29 U.S.C. §623 and Federal transit law at 49 U.S.C. §5332, the Contractor agrees to refrain from discrimination against present and prospective employees for reason of age. In addition, the Contractor agrees to comply with any implementing requirements FTA may issue.
- (3) Disabilities: In accordance with section 102 of the Americans with Disabilities Act, as amended, 42 U.S.C. §12112, the Contractor agrees that it will comply with the requirements of U. S. Equal Employment Opportunity Commission, "Regulations to Implement the Equal Employment Provisions of the Americans with Disabilities Act," 29 C.F.R. Part 1630, pertaining to employment of persons with disabilities. In addition, the Contractor agrees to comply with any implementing requirements FTA may issue.

- c. The Contractor also agrees to include all of these requirements in each subcontract financed in whole or in part with Federal assistance provided by FTA, modified only if necessary to identify the affected parties.
- d. Failure by the contractor, sub-recipient, or subcontractor to carry out these requirements is a material breach of this contract, which may result in the termination of this contract or such other remedy as the recipient deems appropriate.

8. CONFLICT OF INTEREST

- a. Neither the Contractor nor any person or company affiliated with it shall have, during the term of this contract and any extensions thereof, any contractual or other financial relationship with the Authority, with any Authority prime Contractor, or with any subcontractor or supplier to any Authority prime Contractor other than the contractual relationship established under this Contract, unless an exception is granted as described below.
- b. Upon request of the Contractor and upon full disclosure and for good cause the Contracting Officer may in his sole discretion grant an exception to the requirement of a., above, when in his judgment the exception will not create a conflict between the Contractor's duties and obligations under this contract and the duties and obligations imposed on the Contractor under the contractual or other relationship for which an exception is requested.
- c. If, during the performance of this contract and any extension thereof, the Contractor becomes aware of any relationship, financial interest, or other activity in which it or an affiliated person or company is involved which is not in compliance with the provisions of a., above, it shall promptly notify the Contracting Officer in writing and fully disclose all circumstances thereof. Should the Contracting Officer not grant an exception to the requirements of this Article, the Contractor shall, within ten (10) days of written notice from the Contracting Officer to do so, take all action necessary to comply with the terms of a., above.
- d. If the Contractor fails to comply with the terms of this Article, the Contracting Officer, may withhold payments due under the contract until such time as the Contractor is in compliance or, should the non-compliance remain uncorrected at the expiration of ten (10) days from written notice from the Contracting Officer as provided in c., above, terminate the contract for default pursuant to the Default Article of this contract.
- e. The Contractor in performing this Contract shall avoid any conduct which might result in or give the appearance of creating for Directors, Officers or employees of the Authority in their relationship with the Contractor any conflicts of interest or favoritism and/or the appearance thereof and shall avoid any conduct which might result in a Director, Officer or employee failing to adhere to the Standards of Conduct adopted by the Authority's Board of Directors.
- f. Any determination by the Contracting Officer under this Article shall be final and shall be considered a question of fact within the meaning of the Disputes Article of this Contract.

9. CONTRACT WORK HOURS AND SAFETY STANDARDS ACT-OVERTIME COMPENSATION

Pursuant to Section 102 (Overtime):

- (1) **Overtime requirements** - No contractor or subcontractor contracting for any part of the contract work which may require or involve the employment of laborers or mechanics shall require or permit any such laborer or mechanic in any workweek in which he or she is employed on such work to work in excess of forty hours in such workweek unless such laborer or mechanic receives compensation at a rate not less than one and one-half times the basic rate of pay for all hours worked in excess of forty hours in such workweek.
- (2) **Violation; liability for unpaid wages; liquidated damages** - In the event of any violation of the clause set forth in paragraph (1) of this section the contractor and any subcontractor responsible therefor shall be liable for the unpaid wages. In addition, such contractor and subcontractor shall be liable to the United States for liquidated damages. Such liquidated damages shall be computed with respect to each individual laborer or mechanic, including watchmen and guards, employed in violation of the clause set forth in paragraph (1) of this section, in the sum of \$ 10 for each calendar day on which such individual was required or permitted to work in excess of the standard workweek of forty hours without payment of the overtime wages required by the clause set forth in paragraph (1) of this section.
- (3) **Withholding for unpaid wages and liquidated damages** - The Authority shall upon its own action or upon written request of an authorized representative of the Department of Labor withhold or cause to be withheld, from any moneys payable on account of work performed by the contractor or subcontractor under any such contract or any other Federal contract with the same prime contractor, or any other federally-assisted contract subject to the Contract Work Hours and Safety Standards Act, which is held by the same prime contractor, such sums as may be determined to be necessary to satisfy any liabilities of such contractor or subcontractor for unpaid wages and liquidated damages as provided in the clause set forth in paragraph (2) of this section.
- (4) **Subcontracts** - The contractor or subcontractor shall insert in any subcontracts the clauses set forth in this section and also a clause requiring the subcontractors to include these clauses in any lower tier subcontracts. The prime contractor shall be responsible for compliance by any subcontractor or lower tier subcontractor with the clauses set forth in this section.

Section 107 (OSHA):

Contract Work Hours and Safety Standards Act - (i) The Contractor agrees to comply with section 107 of the Contract Work Hours and Safety Standards Act, 40 U.S.C. section 333, and applicable DOL regulations, " Safety and Health Regulations for Construction " 29 C.F.R. Part 1926. Among other things, the Contractor agrees that it will not require any laborer or mechanic to work in unsanitary, hazardous, or dangerous surroundings or working conditions.

- (ii) **Subcontracts** - The Contractor also agrees to include the requirements of this section in each subcontract. The term "subcontract" under this section is considered to refer to a person who agrees to perform any part of the labor or material requirements of a contract for construction, alteration or repair. A person who undertakes to perform a portion of a contract involving the furnishing of supplies or materials will be considered a "subcontractor" under this section if the work in question involves the performance of construction work and is to be performed: (1) directly on or near the construction site, or (2) by the employer for the specific project on a customized basis. Thus, a supplier of materials which will become an integral part of the construction is a "subcontractor" if the supplier fabricates or assembles the goods or materials in question specifically for the construction project and the work involved may be said to be construction activity. If the goods or materials in question are ordinarily sold to other customers from regular inventory, the supplier is not a "subcontractor." The requirements of this section do not apply to contracts or subcontracts for the purchase of supplies or materials or articles normally available on the open market.

10. CONVICT LABOR

In connection with the performance of work under this Contract, the Contractor agrees not to employ any person undergoing sentence of imprisonment except as provided by Public Law 89-176, September 10, 1965.

11. CORRECTION OF DEFICIENCIES

a. Definitions: As used in this article:

- (1) Deficiency means any condition or characteristics in any supplies (which term shall include related technical data) or services furnished hereunder, which is not in compliance with the requirements of this Contract.
- (2) Correction means any and all actions necessary to eliminate any and all deficiencies.
- (3) Supplies mean the end item(s) furnished by the Contractor and related services required under this Contract.

b. General:

- (1) The rights and remedies of the Authority provided in this article:
 - (a) Shall not be affected in any way by any other provisions under this Contract concerning the conclusiveness of inspection and acceptance; and
 - (b) Are in addition to and do not limit any rights afforded to the Authority by any other article of this Contract.
- (2) This article shall apply only to those deficiencies discovered by either the Authority or the Contractor within one year after acceptance.

- (3) The Contractor shall not be responsible under this article for the correction of deficiencies in Authority furnished property, except for deficiencies in installation, unless the Contractor performs or is obligated to perform any modifications or other work on such property. In that event, the Contractor shall be responsible for correction of deficiencies to the extent of such modifications or other work.
 - (4) The Contractor shall not be responsible under this article for the correction of deficiencies caused by the Authority.
- c. Deficiencies in accepted supplies or services:
 - (1) Notice to Contractor - Recommendation for Correction: If the Contracting Officer determines that a deficiency exists in any of the supplies or services accepted by the Authority under this Contract, he shall promptly notify the Contractor of the deficiency, in writing, within 30 days. Upon timely notification of the existence of such a deficiency, or if the Contractor independently discovers a deficiency in accepted supplies or services, the Contractor shall promptly submit to the Contracting Officer his recommendation for corrective actions, together with supporting information in sufficient detail for the Contracting Officer to determine what corrective action, if any, shall be undertaken.
 - (2) Direction to Contractor concerning correction of deficiencies: Within 30 days after receipt of the Contractor's recommendations for corrective action and adequate supporting information, the Contracting Officer, at his sole discretion, shall give the Contractor written notice not to correct any deficiency, or to correct or partially correct any deficiency within a reasonable time and at a specified location.
 - (3) Correction of deficiencies by Contractor: The Contractor shall promptly comply with any timely written direction by the Contracting Officer to correct or partially correct a deficiency, at no increase in the Contract price. The Contractor shall also prepare and furnish to the Authority data and reports applicable to any correction required under this article (including revision and updating of all other affected data called for under this Contract) at no increase in the Contract price.
 - (4) Modification of Contract With respect to uncorrected deficiencies: In the event of timely notice of a decision not to correct or only to partially correct, the Contractor shall promptly submit a technical and cost proposal to amend the Contract to permit acceptance of the affected supplies or services in accordance with the revised requirements, and an equitable reduction in Contract price shall promptly be negotiated by the parties and reflected in a supplemental agreement to this Contract.
- d. Deficiencies in supplies or services not yet accepted: If the Contractor becomes aware at any time before acceptance by the Authority (whether before or after tender to the Authority) that a deficiency exists in any supplies or services, he shall promptly correct the deficiency or, if he elects to invoke the procedures in paragraph c. above, he shall promptly communicate information concerning the deficiency to the Contracting Officer, in writing, together with his detailed recommendation for corrective action.

- e. No extension in time for performance; no increase in Contract price.
 - (1) In no event shall the Authority be responsible for extension or delays in the schedule deliveries or periods of performance under this Contract as a result of the Contractor's obligations to correct deficiencies, nor shall there be any adjustment of the delivery schedule or period of performance as a result of such correction of deficiencies, except as may be agreed to by the Authority in a supplemental agreement with adequate consideration.
 - (2) It is hereby specifically recognized and agreed by the parties hereto that this article shall not be construed as obligating the Authority to increase the Contract price of this Contract.

- f. Transportation charges:
 - (1) When the Authority returns supplies to the Contractor for correction or replacement pursuant to this article, the Contractor shall be liable for transportation charges up to an amount equal to the cost of transportation by the usual commercial method of shipment from the designated destination point under this Contract to the Contractor's plant, in addition to any charges provided for by (2) below. The Contractor shall also bear the responsibility for the supplies while in transit.
 - (2) When compliance with the terms of this article by the Contractor involves shipment of corrected or replacement supplies from the Contractor to the Authority, the Contractor shall be liable for transportation charges up to an amount equal to the cost of transportation by the usual commercial method of shipment from the Contractor's plant to the designated destination point under this Contract, in addition to any charges provided for by (1) above. The Contractor shall also bear the responsibility for the supplies while in transit.

- g. Failure to correct: If the Contractor fails or refuses to
 - (1) present a detailed recommendation for corrective action in accordance with c. above,
 - (2) correct deficiencies in accordance with c. (3) above, or
 - (3) prepare and furnish data and reports in accordance with paragraph c. (3) above,

the Contracting Officer shall give the Contractor written notice specifying the failure or refusal and setting a period after receipt of the notice within which it must be cured. If the failure or refusal is not cured within the specified period, the Contracting Officer may, by contract or otherwise, as required:

 - (1) Obtain detailed recommendations for corrective action;
 - (2)(a) Correct the supplies or services, or
 - (b) Replace the supplies or services; and if the Contractor fails to furnish timely disposition instructions, the Contracting Officer may dispose of nonconforming

supplies for the Contractor's account in a reasonable manner, in which case the Authority is entitled to reimbursement from the Contractor or from the proceeds for the reasonable expenses of care and disposition, as well as for excess costs incurred or to be incurred; and

- (3) Obtain applicable data and reports and charge to the Contractor the cost occasioned to the Authority thereby.
- h. Correction of deficient replacements and re-performances: Any supplies or parts thereof corrected or furnished in replacement and any services re-performed pursuant to this article shall also be subject to all the provisions of the article to the same extent as supplies or services initially accepted.
- i. Disassembly/reassembly expense: The Contractor shall be liable for reasonable cost of disassembly/reassembly of larger items necessary to remove the supplies to be inspected and/or returned for correction or replacement.

12. COST OR PRICING DATA

- a. The Contractor shall submit to the Contracting Officer, either actually or by specific identification in writing, cost or pricing data under the conditions described in this paragraph and certify that, to the best of his knowledge and belief, the cost or pricing data submitted is accurate, complete, and current as of the date of execution, which date shall be as close as possible to the date of agreement on the negotiated price of the Contract modification. The cost or pricing data shall be submitted at the time the Contractor submits his proposal for the pricing of any modification to this Contract, whether or not cost or pricing data was required in connection with the initial pricing of the Contract, when the modification involves aggregate increases and/or decreases in costs plus applicable profits expected to exceed \$100,000, or less at the discretion of the Contracting Officer.
- b. The submittal of certified cost or pricing data shall not be required if the price is based on adequate price competition, established catalog or market prices of commercial items sold in substantial quantities to the general public, or prices set by law or regulation. The Contractor agrees that the terms adequate price competition and established catalog or market prices of commercial items sold in substantial quantities to the general public shall be determined by the Contracting Officer in accordance with the guidelines as set forth in Subpart 15.4 of the Federal Acquisition Regulations (48 CFR 15.4).
- c. Cost or pricing data consists of all facts existing up to the time of agreement on price which prudent buyers and sellers would reasonably expect to have a significant effect on the price negotiations for the modification. The definition of cost or pricing data embraces more than historical accounting data; it also includes where applicable, such factors as subcontractor, supplier and vendor quotations, non-recurring costs, changes in construction methods, unit cost trends such as those associated with labor efficiency and any management decisions which could reasonably be expected to have a significant bearing on costs under the proposed modification and the Contract work. Cost or pricing data consists of all facts which can reasonably be expected to contribute to sound estimates of future costs as well as to the validity of costs already incurred. Cost or pricing data, being factual, is that type of information which can be verified. Because the certificate pertains to cost or pricing data, it does not make representations as to the accuracy of the Contractor's

judgment on the estimated portion of future costs or projections. The certificate does, however, apply to the data upon which the Contractor's judgment is based.

13. COVENANT AGAINST CONTINGENT FEES

The Contractor warrants that no person or selling agency has been employed or retained to solicit or secure this Contract upon an agreement or understanding for a commission, percentage, brokerage, or contingent fee, excepting bona fide employees or bona fide established commercial or selling agencies maintained by the Contractor for the purpose of securing business. For breach or violation of this warranty, the Authority shall have the right to annul this Contract without liability or in its discretion, to deduct from the Contract price or consideration, or otherwise recover, the full amount of such commission, percentage, brokerage, or contingent fee.

14. DEFAULT

- a. The Authority may, subject to the provisions of paragraph c. below, by written notice of default to the Contractor, terminate the whole or any part of this Contract in any one of the following circumstances:
 - (1) If the Contractor fails to make delivery of the supplies or to perform the services within the time specified herein or any extension thereof; or
 - (2) If the Contractor fails to perform any of the other provisions of this Contract, or so fails to make progress as to endanger performance of this Contract in accordance with its terms, and in either of these two circumstances does not cure such failure within a period of 10 days (or such longer period as the Contracting Officer may authorize in writing) after receipt of notice from the Contracting Officer specifying such failure.
- b. In the event the Authority terminates this Contract in whole or in part as provided in paragraph a. of this article, the Authority may procure, upon such terms and in such manner as the Contracting Officer may deem appropriate, supplies or services similar to those so terminated, and the Contractor shall be liable to the Authority for any excess costs for such similar supplies or services; provided, that the Contractor shall continue the performance of this Contract to the extent not terminated under the provisions of this article.
- c. Except with respect to defaults of subcontractors, the Contractor shall not be liable for any excess costs if the failure to perform the Contract arises out of causes beyond the control and without the fault or negligence of the Contractor. Such causes may include, but are not restricted to, acts of God or of the public enemy, acts of the Government in its sovereign capacity or the Authority in its contractual capacity, fires, floods, epidemics, quarantine restrictions, strikes, freight embargoes, and unusually severe weather; but in every case the failure to perform must be beyond the control and without the fault or negligence of the Contractor. If the failure to perform is caused by the default of a subcontractor, and if such default arises out of causes beyond the control of both the Contractor and subcontractor, and without the fault or negligence of either of them, the Contractor shall not be liable for any excess costs for failure to perform, unless the supplies or services to be furnished by the subcontractor were obtainable from other sources in sufficient time to permit the Contractor to meet the required delivery schedule.

- d. If this Contract is terminated as provided in paragraph a. of this article, the Authority, in addition to any other rights provided in this article, may require the Contractor to transfer title and deliver to the Authority, in the manner and to the extent directed by the Contracting Officer,
- (1) any completed supplies, and
 - (2) such partially completed supplies and materials, parts, tools, dies, jigs, fixtures, plans, drawings, information, and contract rights (hereinafter called "manufacturing materials") as the Contractor has specifically produced or specifically acquired for the performance of such part of this Contract as has been terminated; and the Contractor shall, upon direction of the Contracting Officer, protect and preserve property in the possession of the Contractor in which the Authority has an interest. Payment for completed supplies delivered to and accepted by the Authority shall be at the Contract price. Payment for manufacturing materials delivered to and accepted by the Authority and for the protection and preservation of property shall be in an amount agreed upon by the Contractor and Contracting Officer; failure to agree to such amount shall be a dispute concerning a question of fact within the meaning of the DISPUTES article of this Contract. The Authority may withhold from amounts otherwise due the Contractor for such completed supplies or manufacturing materials such sum as the Contracting Officer determines to be necessary to protect the Authority against loss because of outstanding liens or claims of former lien holders.
- e. If, after notice of termination of this Contract under the provisions of article, it is determined for any reason that the Contractor was not in default under the provisions of this article, or that the default was excusable under the provisions of this article, the rights and obligations of the parties shall, if the Contract contains an article providing for termination for convenience of the Authority, be the same as if the notice of termination had been issued pursuant to such article. If, after notice of termination of this Contract under the provisions of this article, it is determined for any reason that the Contractor was not in default under the provisions of this article, and if this Contract does not contain an article providing for termination for convenience of the Authority, the Contract shall be equitably adjusted to compensate for such termination and the Contract modified accordingly; failure to agree to such adjustment shall be a dispute concerning a question of fact within the meaning of the DISPUTES article of this Contract.
- f. If the Contractor fails to deliver the supplies or perform the services within the time specified in this Contract, or any extension thereof, the actual damage to the Authority for the delay will be difficult or impossible to determine. Therefore in lieu of actual damages, the Contractor shall pay to the Authority as fixed, agreed and liquidated damages for each calendar day of delay, the amount set forth elsewhere in this Contract. Alternatively, the Authority may terminate this Contract in whole or in part as provided in paragraph a. of this article, and in that event the Contractor shall be liable, in addition to the excess costs provided in paragraph b. above, for such liquidated damages accruing until such time as the Authority may reasonably obtain delivery or performance of similar supplies or services. The Contractor shall not be charged with liquidated damages when the delay arises out of causes beyond the control and without the fault or negligence of the Contractor, as defined in paragraph c. above, and in such event, subject to the DISPUTES article, the Contracting Officer shall ascertain the facts and extent of the delay and shall extend the time for

performance of the contract when in his judgment the findings of fact justify an extension.

- g. The rights and remedies of the Authority provided in this article shall not be exclusive and are in addition to any other rights and remedies provided by law or under this Contract.
- h. As used in paragraph c. of this clause, the terms subcontractor and subcontractors mean subcontractor(s) at any tier.

15. DELAY OF WORK

- a. If the performance of all or any part of the work is delayed or interrupted by an act of the Contracting Officer in the administration of this Contract, which act is not expressly or impliedly authorized by this Contract, or by his failure to act within the time specified, an adjustment (excluding profit) shall be made for any increase in the cost of performance of this Contract caused by such delay or interruption and the contract modified in writing accordingly. Adjustment shall be made also in the delivery or performance dates and any other contractual provision affected by such delay or interruption. However, no adjustment shall be made under this article for any delay or interruption
 - (1) to the extent that performance would have been delayed or interrupted by any other cause, including the fault or negligence of the Contractor; or
 - (2) for which an adjustment is provided or excluded under any other provision of this Contract.
- b. No claim under this clause shall be allowed
 - (1) for any costs incurred more than 20 days before the Contractor shall have notified the Contracting Officer in writing of the act or failure to act involved; and
 - (2) unless the claim, in an amount stated, is asserted in writing as soon as practicable after the termination of such delay or interruption, but not later than the date of final payment under the Contract.

16. RESOLUTION OF DISPUTES

- a. Except as otherwise provided in this Contract, any dispute concerning a question of fact arising under or related to this Contract which is not disposed of by agreement shall be decided by the Contracting Officer, who shall reduce his/her decision to writing and mail or otherwise furnish a copy thereof to the Contractor. The decision of the Contracting Officer shall be final and conclusive unless, within thirty (30) calendar days from the date of receipt of such copy, the Contractor mails or otherwise furnishes to the Contracting Officer a written notice of appeal addressed to the Authority Board of Directors. Such notice would indicate that an appeal is intended and should reference the decision and contract number. The decision of the Board of Directors or its duly authorized representative for the determination of such appeals shall be final and conclusive unless in proceedings initiated by either party for review of such decision in a court of competent jurisdiction, the court determines the decision to have been fraudulent, or capricious, or arbitrary, or so

grossly erroneous as necessarily to imply bad faith, or is not supported by substantial evidence. In connection with any appeal proceeding under this article, the Contractor, or the Authority, as the case may be, shall be afforded an opportunity to be heard and offer evidence in support of its appeal. Pending final decision of a dispute hereunder, the Contractor shall proceed diligently with the performance of the Contract and in accordance with the Contracting Officer's decision. The Armed Services Board of Contract Appeals is the authorized representative of the Board of Directors for finally deciding appeals to the same extent as could the Board of Directors.

- b. This DISPUTES article does not preclude consideration of question of law in connection with decisions provided for in Section a. above. Nothing in the Contract, however, shall be construed as making final the decisions of the Board of Directors or its representative on a question of law.

17. EMPLOYMENT RESTRICTION WARRANTY

- a. The Contractor warrants that it will not offer employment to any officer or employee of the Washington Metropolitan Area Transit Authority (WMATA) who has been involved, directly or indirectly, in any matter of financial interest to the Contractor until at least one year after the officer or employee has ceased involvement in or responsibility for the matter.
- b. The Contractor further warrants that it will not employ any WMATA officer or employee who has had direct responsibility for any matter of financial interest to the Contractor within the year prior to the retirement or termination of the officer or employee until at least one full year after such officer or employee has left the employment of the Authority.
- c. The one year requirement described in a. and b. above may be waived at the discretion of the Contracting Officer if the WMATA employee or former employee has been subject to a Reduction in Force; in such case, the Contracting Officer will provide the Contractor with a letter to that effect.
- d. If a waiver is granted, or if a former employee of WMATA is eventually hired, the Contractor shall be responsible for ensuring that the former employee is not directly involved in negotiating or otherwise dealing with WMATA on any particular matter over which such employee had responsibility during his or her period of employment at WMATA.
- e. Should the Contractor fail to comply with paragraphs a., b. or d. above, the Contracting Officer shall have the right to withhold payment under this Contract in an amount not to exceed 2% of the total Contract amount as liquidated damages to the Authority, such withholding to be in addition to any other withholding under this Contract. Further, the Contracting Officer shall consider such violation in evaluating the Contractor's responsibility in connection with award of any other Authority Contract.

18. EXTRAS

Except as otherwise provided in this Contract, no payment for extras shall be made unless such extras and the price therefor have been authorized in writing in advance by the Contracting Officer.

19. FEDERAL, STATE AND LOCAL TAXES

- a. Except as may be otherwise provided in this Contract, the Contract price includes all applicable Federal, State, and Local taxes and duties.
- b. Nevertheless, with respect to any Federal excise tax or duty on the transactions or property covered by this Contract, if a statute, court decision, written ruling, or regulation takes effect after the Contract date, and:
 - (1) Results in the Contractor being required to pay or bear the burden of any such Federal excise tax or duty or increase in the rate thereof which would not otherwise have been payable on such transactions or property, the Contract price shall be increased by the amount of such tax or duty or rate increase, provided the Contractor warrants in writing that no amount for such newly imposed Federal excise tax or duty or rate increase was included in the Contract price as a contingency reserve or otherwise; or
 - (2) Results in the Contractor not being required to pay or bear the burden of, or in his obtaining a refund or drawback of, any such Federal excise tax or duty which would otherwise have been payable on such transactions or property or which was the basis of an increase in the Contract price, the Contract price shall be decreased by the amount of the relief, refund, or drawback, or that amount shall be paid to the Authority, as directed by the Contracting Officer. The Contract price shall be similarly decreased if the Contractor, through his fault or negligence or his failure to follow instructions of the Contracting Officer, is required to pay or bear the burden of, or does not obtain a refund or drawback of, any such Federal excise tax or duty.
- c. Paragraph b. above shall not be applicable to social security taxes or to any other employment tax.
- d. No adjustment of less than \$100 shall be made in the Contract price pursuant to paragraph b. above.
- e. As used in paragraph b. above, the term Contract date means the Contract date. As to additional supplies or services procured by modification to this Contract, the term Contract date means the date of such modification.
- f. Unless there does not exist any reasonable basis to sustain an exemption, the Authority upon the request of the Contractor shall, without further liability, furnish evidence appropriate to establish exemption from any Federal, State or Local tax; provided that evidence appropriate to establish exemption from any Federal excise tax or duty which may give rise to either an increase or decrease in the Contract price will be furnished only at the discretion of the Authority.

- g. The Contractor shall promptly notify the Contracting Officer of matters which will result in either an increase or decrease in the Contract price and shall take action with respect thereto as directed by the Contracting Officer.

20. GRATUITIES

- a. In connection with performance of work required under this Contract, or any changes or modifications relative thereto, the giving of or offering to give gratuities (in the form of entertainment, gifts or otherwise) by the Contractor, or any agent, representative or other person deemed to be acting on behalf of the Contractor, or any supplier or subcontractor furnishing material to or performing work under this Contractor, or any agent, representative or other person deemed to be acting on behalf of such supplier or subcontractor, to any Director, Officer or employee of the Authority; or to any Director, Officer, employee or agent of any of the Authority's agents, consultants, representatives or other persons deemed to be acting for or on behalf of the Authority with a view toward securing a contract or securing favorable treatment with respect to the awarding or amending, or the making of any determinations with respect to the performing of such contract is expressly forbidden. The terms of this GRATUITIES article shall be strictly construed and enforced in the event of violations hereto.
- b. Reported instances of the giving or offering to give gratuities within the context of this GRATUITIES article will be investigated by the Board of Directors or its duly authorized representative. A preliminary investigation will be made to determine whether there is probable cause to suspect that a violation of this article has been committed. If such probable cause is found to exist, the Board of Directors, or its duly authorized representative, shall formally notify the suspected donor corporation or individual in writing of the particulars of the event; and provide such donor the opportunity to be heard on the matter. The aims of the investigations and hearing shall be to ensure due process and to preserve the best interests and rights of all parties by the full and fair disclosure of all relevant and material information. Accordingly, the Board of Directors, or its duly authorized representative, shall require production of all pertinent documents and records, and sworn testimony from witnesses. During the pendency of any investigation or hearing treating with a violation of this GRATUITIES article, the Board of Directors, or its duly authorized representative may exercise its power granted by the Washington Metropolitan Area Transit Authority Compact, Public Law 774, 80 Star. 1324, Article V, General Powers, Subparagraph (k), by issuing subpoenas to compel the attendance of necessary witnesses, and to compel production of papers, records, accounts, ledgers and documents. The subpoenas shall be enforceable by order of an appropriate United States District Court. If, after notice and hearing, or notice of the opportunity to be heard, the Board of Directors, or its duly authorized representative, finds that a violation of this GRATUITIES article has been committed, the Authority shall have the right to:
 - (1) Require that the individual(s) giving or offering the gratuity be removed from further participation on any Authority projects (be terminated);
 - (2) Deny the Contractor any G & A (general and administrative) mark-ups for all changes and/or modifications found to be tainted by the giving of or offering to give gratuities;

- (3) Preclude the Contractor from proposing, receiving or participating as joint venturer, subcontractor or otherwise in any Authority project for a period of five years;
 - (4) Have complete access to all the Contractor's financial books, records and accounts for the purpose of performing a comprehensive audit of the entire project.
 - (5) In the event of repeated violations of this GRATUITIES article or of gross or extreme conduct indicative of a corrupt intent to gain special advantage, by written notice to the Contractor, terminate the right of the Contractor to proceed under the Contract.
- c. The existence of the facts upon which the Board of Directors, or its duly authorized representative, makes findings in connection with investigations and hearings in consonance herewith shall be an issue and may be reviewed in any competent court.
- d. In the event this Contract is terminated as provided in paragraph b. (5) hereof, the Authority shall be entitled
- (1) to pursue the same remedies against the Contractor as it could pursue in the event of a breach of the Contract by the Contractor, and
 - (2) as a penalty in addition to any other damages to which it may be entitled by law, to exemplary damages in any amount (as determined by the Board or its duly authorized representative) which shall be not less than three nor more than ten times the costs incurred by the Contractor in providing any such gratuities to any such officer or employee.
- e. The rights and remedies of the Authority provided in this article shall not be exclusive and are in addition to any other rights and remedies provided by law or under this Contract.

21. INSPECTION OF SERVICES

- a. "Services" as used in this clause, includes services performed, workmanship, and material furnished or utilized in the performance of services.
- b. The Contractor shall provide and maintain an inspection system acceptable to the Authority covering the services under this contract. Complete records of all inspection work performed by the Contractor shall be maintained and made available to the Authority during contract performance and for as long afterwards as the Contract requires.
- c. The Authority has the right to inspect and test all services called for by this contract, to the extent practicable at all times and places during the term of the contract. The Authority shall perform inspection and tests in a manner that will not unduly delay the work.
- d. If the Authority performs inspections or tests on the premises of the Contractor or a subcontractor, the Contractor shall furnish, and shall require subcontractors to furnish, at non-increase in contract price, all reasonable facilities and assistance for the safe and convenient performance of these duties.

- e. If any of the services performed do not conform to contract requirements, the Authority may require the Contractor to perform the services again in conformity with contract requirements, for no additional fee. When the defects in performance cannot be corrected by re-performance, the Authority may:
 - (1) Require the Contractor to take necessary action to ensure that future performance conforms to contract requirements; or
 - (2) Reduce the contract price to reflect the reduced value of the services performed.
- f. If the Contractor fails to promptly perform the services again or to take the necessary action to ensure future performance in conformity with contract requirements, the Authority may:
 - (1) By contract or otherwise, perform the services and charge to the contractor any cost incurred by the Authority that is directly related to the performance of the service; or
 - (2) Terminate the contract for default.

22. INSPECTION OF SUPPLIES

- a. Definition. "Supplies," as used in this clause, includes but is not limited to raw materials, components, intermediate assemblies, end products, and lots of supplies.
- b. The Contractor shall provide and maintain an inspection system acceptable to the Authority covering supplies under this contract and shall tender to the Authority for acceptance only supplies that have been inspected in accordance with the inspection system and have been found by the Contractor to be in conformity with contract requirements. As part of the system, the Contractor shall prepare records evidencing all inspections made under the system and the outcome. These records shall be kept complete and made available to the Authority during contract performance and for as long afterwards as the contract requires. The Authority may perform reviews and evaluations as reasonably necessary to ascertain compliance with this paragraph. These reviews and evaluations shall be conducted in a manner that will not unduly delay the contract work. The right of review, whether exercised or not, does not relieve the Contractor of the obligations under the contract.
- c. The Authority has the right to inspect and test all supplies called for by the contract, to the extent practicable, at all places and times, including the period of manufacture, and in any event before acceptance. The Authority shall perform inspections and tests in a manner that will not unduly delay the work. The Authority assumes no contractual obligation to perform any inspection and test for the benefit of the Contractor unless specifically set forth elsewhere in this contract.
- d. If the Authority performs inspection or test on the premises of the Contractor or a subcontractor, the Contractor shall furnish, and shall require subcontractors to furnish, at no increase in contract price, all reasonable facilities and assistance for the safe and convenient performance of these duties. Except as otherwise provided in the contract, the Authority shall bear the expense of Authority inspections or tests made at other than the Contractor's or subcontractor's premises; provided, that in

case of rejection, the Authority shall not be liable for any reduction in the value of inspection or test samples.

- e. When supplies are not ready at the time specified by the Contractor for inspection or test, the Contracting Officer may charge to the Contractor the additional cost of inspection or test. The Contracting Officer may also charge the Contractor for any additional cost of inspection or test when prior rejection makes reinspection or retest necessary.
- f. The Authority has the right either to reject or to require correction of nonconforming supplies. Supplies are nonconforming when they are defective in material or workmanship or are otherwise not in conformity with contract requirements. The Authority may reject nonconforming supplies with or without disposition instructions.
- g. The Contractor shall remove supplies rejected or required to be corrected. However, the Contracting Officer may require or permit correction in place, promptly after notice, by and at the expense of the Contractor. The Contractor shall not tender for acceptance corrected or rejected supplies without disclosing the former rejection or requirement for correction, and, when required, shall disclose the corrective action taken.
- h. If the Contractor fails to promptly remove, replace, or correct rejected supplies that are required to be removed or to be replaced or corrected, the Authority may either (1) by contract or otherwise, remove, replace, or correct the supplies and charge the cost to the Contractor or (2) terminate the contract for default. Unless the Contractor corrects or replaces the supplies within the delivery schedule, the Contracting Officer may require their delivery and make an equitable price reduction. Failure to agree to a price reduction shall be a dispute.
- i. If this contract provides for the performance of Authority quality assurance at source, and if requested by the Authority, the Contractor shall furnish advance notification of the time when Contractor inspection or tests will be performed in accordance with the terms and conditions of the contract; and when the supplies will be ready for Authority inspection. The Authority's request shall specify the period and method of the advance notification and the Authority representative to whom it shall be furnished. Requests shall not require more than two (2) workdays of advance notification if the Authority representative is in residence in the Contractor's plant, nor more than seven (7) workdays in other instances.
- j. The Authority shall accept or reject supplies as promptly as practicable after delivery, unless otherwise provided in the contract. Authority failure to inspect and accept or reject the supplies shall not relieve the Contractor from responsibility, nor impose liability on the Authority, for nonconforming supplies.
- k. Inspections and tests by the Authority do not relieve the Contractor of responsibility for defects or other failures to meet contract requirements discovered before acceptance. Acceptance shall be conclusive, except for latent defects, fraud, gross mistakes amounting to fraud, or as otherwise provided in the contract.
- l. If acceptance is not conclusive for any of the reasons in paragraph (k) hereof, the Authority, in addition to any other rights and remedies provided by law, or under other provisions of this contract, shall have the right to require the Contractor (1) at no increase in contract price, to correct or replace the defective or nonconforming

supplies at the original point of delivery or at the Contractor's plant at the Contracting Officer's election, and in accordance with a reasonable delivery schedule as may be agreed upon between the Contractor and the Contracting Officer; provided, that the Contracting Officer may require a reduction in contract price if the Contractor fails to meet such delivery schedule, or (2) within a reasonable time after receipt by the Contractor of notice of defects or nonconformance, to repay such portion of the contract as is equitable under the circumstances if the Contracting Officer elects not to require correction or replacement. When supplies are returned to the Contractor, the Contractor shall bear the transportation cost from the original point of delivery to the Contractor's plant and return to the original point when that point is not the Contractor's plant. If the Contractor fails to perform or act as required in paragraph (I)(1) or (I)(2) of this clause and does not cure such failure within a period of ten (10) calendar days (or such longer period as the Contracting Officer may authorize in writing) after receipt of notice from the Contracting Officer specifying such failure, the Authority shall have the right by contract or otherwise to replace or correct such supplies and charge to the Contractor the cost occasioned the Authority thereby.

23. LIMITATION ON WITHHOLDING PAYMENTS

If more than one article or schedule provision of this Contract authorizes the temporary withholding of amounts otherwise payable to the Contractor for supplies delivered or services performed, the total of the amounts so withheld at any one time shall not exceed the greatest amount which may be withheld under any one such article or schedule provision at that time; provided, that this limitation shall not apply to:

- a. Withholdings pursuant to any clause relating to wages or hours of employees;
- b. Withholdings not specifically provided for by this Contract; and
- c. The recovery of overpayment.

24. NEW MATERIAL

Except as to any supplies and components which the Specifications or schedule specifically provides need not be new, the Contractor represents that the supplies and components to be provided under this Contract are new (not used or reconditioned, and not of such age or so deteriorated as to impair their usefulness or safety). If at any time during the performance of this Contract, the Contractor believes that the furnishing of supplies or components which are not new is necessary or desirable, he shall notify the Contracting Officer immediately, in writing, including the reasons therefor and proposing any consideration which will flow to the Authority if authorization to use such supplies is granted.

25. NOTICE AND ASSISTANCE REGARDING PATENT AND COPYRIGHT INFRINGEMENT

The provisions of this article shall be applicable only if the amount of this Contract exceeds \$10,000.

- a. The Contractor shall report to the Contracting Officer, promptly and in reasonable written detail, each notice or claim of patent or copyright infringement based on the performance of this Contract of which the Contractor has knowledge.
- b. In the event of any claim or suit against the Authority on account of any alleged patent or copyright infringement arising out of the performance of this Contract or out

of the use of any supplies furnished or work or services performed hereunder, the Contractor shall furnish to the Authority, when requested by the Contracting Officer, all evidence and information in possession of the Contractor pertaining to such suit or claim. Such evidence and information shall be furnished at the expense of the Authority except where the Contractor has agreed to indemnify the Authority.

- c. This clause shall be included in all subcontracts.

26. NOTICE TO THE AUTHORITY OF LABOR DISPUTES

- a. Whenever the Contractor has knowledge that any actual or potential labor dispute is delaying or threatens to delay the timely performance of this Contract, the Contractor shall immediately give notice thereof, including all relevant information with respect thereto, to the Contracting Officer.
- b. The Contractor agrees to insert the substance of this clause, including this paragraph b., in any subcontract hereunder as to which a labor dispute may delay the timely performance of this Contract; except that each such subcontract shall provide that in the event its timely performance is delayed or threatened by delay by any actual or potential labor dispute, the subcontractor shall immediately notify his next higher tier subcontractor, or the Contractor, as the case may be, of all relevant information with respect to such dispute.

27. OFFICIALS NOT TO BENEFIT

- a. No member of or delegate to Congress, or resident commissioner, shall be admitted to any share or part of this Contract, or to any benefit that may arise therefrom; but this provision shall not be construed to extend to this Contract if made with a corporation for its general benefit.
- b. No member, officer, or employee of the Public Body or of a local public body during his tenure or one year thereafter shall have any interest, direct or indirect, in this Contract or the proceeds thereof.

28. ORDER OF PRECEDENCE

Any inconsistency in this solicitation or Contract shall be resolved by giving precedence in the following order: (a) Contract Amendments/Modifications; (b) Solicitation Offer and Award Forms; (c) Representations and Certifications; (d) Price Proposal as Negotiated; (e) General Provisions; (f) WMATA Standard Specifications and Technical Specifications of the Contract, whether incorporated by reference or otherwise; (g) other documents, exhibits, and attachments; and (h) drawings, if any. In the event of a conflict within, between or among all the above listed order of precedent, the more stringent requirement shall apply.

29. PATENT AND RIGHTS IN DATA

- a. Rights in Data - The following requirements apply to each contract involving experimental, developmental or research work:
 - (1) The term "subject data" used in this section means recorded information, whether or not copyrighted, that is delivered or specified to be delivered under this contract. The term includes graphic or pictorial delineation in media such as drawings or photographs; text in specifications or related

performance or design-type documents; machine forms such as punched cards, magnetic tape, or computer memory printouts; and information retained in computer memory. Examples include, but are not limited to: computer software, engineering drawings and associated lists; specifications, standards, process sheets, manuals, technical reports, catalog item identifications, and related information. The term "subject data" does not include financial reports, cost analyses, and similar information incidental to Project administration.

- (2) The following restrictions apply to all subject data first produced in the performance of this contract.
- (a) Except for its own internal use, the Authority or Contractor may not publish or reproduce subject data in whole or in part, or in any manner or form, nor may the Authority or Contractor authorize others to do so, without the written consent of the Federal Government, until such time as the Federal Government may have either released or approved the release of such data to the public; this restriction on publication, however, does not apply to any contract with an academic institution
 - (b) In accordance with 49 CFR § 18.34 and 49 CFR § 19.36, the Federal Government reserves a royalty-free, non-exclusive and irrevocable license to reproduce, publish, or otherwise use, and to authorize others to use, for "Federal Government purposes," any subject data or copyright described in subsections (2)(b)1 and (2)(b)2 of this clause below. As used in the previous sentence, "for Federal Government purposes," means use only for the direct purposes of the Federal Government. Without the copyright owner's consent, the Federal Government may not extend its Federal license to any other party.
 - i. Any subject data developed under that contract, whether or not a copyright has been obtained; and
 - ii. Any rights of copyright purchased by the Authority or Contractor using Federal assistance in whole or in part provided by FTA.
 - (c) When FTA awards Federal assistance for experimental, developmental, or research work, it is FTA's general intention to increase transportation knowledge available to the public, rather than to restrict the benefits resulting from the work to participants in that work. Therefore, unless FTA determines otherwise, the Authority and the Contractor performing experimental, developmental, or research work required by the underlying contract to which this Attachment is added agrees to permit FTA to make available to the public, either FTA's license in the copyright to any subject data developed in the course of that contract, or a copy of the subject data first produced under the contract for which a copyright has not been obtained. If the experimental, developmental, or research work, which is the subject of the underlying contract, is not completed for any reason whatsoever, all data developed under that contract shall become

- subject data as defined in subsection (a) of this clause and shall be delivered as the Federal Government may direct. This subsection (c), however, does not apply to adaptations of automatic data processing equipment or programs for the Authority or Contractor's use whose costs are financed in whole or in part with Federal assistance provided by FTA for transportation capital projects.
- (d) Unless prohibited by state law, upon request by the Federal Government, the Authority and the Contractor agree to indemnify, save, and hold harmless the Federal Government, its officers, agents, and employees acting within the scope of their official duties against any liability, including costs and expenses, resulting from any willful or intentional violation by the Authority or Contractor of proprietary rights, copyrights, or right of privacy, arising out of the publication, translation, reproduction, delivery, use, or disposition of any data furnished under that contract. Neither the Authority nor the Contractor shall be required to indemnify the Federal Government for any such liability arising out of the wrongful act of any employee, official, or agents of the Federal Government.
 - (e) Nothing contained in this clause on rights in data shall imply a license to the Federal Government under any patent or be construed as affecting the scope of any license or other right otherwise granted to the Federal Government under any patent.
 - (f) Data developed by the Authority or Contractor and financed entirely without using Federal assistance provided by the Federal Government that has been incorporated into work required by the underlying contract to which this Attachment has been added is exempt from the requirements of subsections (b), (c), and (d) of this clause, provided that the Authority or Contractor identifies that data in writing at the time of delivery of the contract work.
 - (g) Unless FTA determines otherwise, the Contractor agrees to include these requirements in each subcontract for experimental, developmental, or research work financed in whole or in part with Federal assistance provided by FTA.
- (3) Unless the Federal Government later makes a contrary determination in writing, irrespective of the Contractor's status (i.e. , a large business, small business, state government or state instrumentality, local government, nonprofit organization, institution of higher education, individual, etc.), the Authority and the Contractor agree to take the necessary actions to provide, through FTA, those rights in that invention due the Federal Government as described in U.S. Department of Commerce regulations, "Rights to Inventions Made by Nonprofit Organizations and Small Business Firms Under Government Grants, Contracts and Cooperative Agreements," 37 C.F.R. Part 401.
 - (4) The Contractor also agrees to include these requirements in each subcontract for experimental, developmental, or research work financed in whole or in part with Federal assistance provided by FTA.

- b. Patent Rights - The following requirements apply to each contract involving experimental, developmental, or research work:
- (1) General - If any invention, improvement, or discovery is conceived or first actually reduced to practice in the course of or under the contract to which this Attachment has been added, and that invention, improvement, or discovery is patentable under the laws of the United States of America or any foreign country, the Authority and Contractor agree to take actions necessary to provide immediate notice and a detailed report to the party at a higher tier until FTA is ultimately notified.
 - (2) Unless the Federal Government later makes a contrary determination in writing, irrespective of the Contractor's status (a large business, small business, state government or state instrumentality, local government, nonprofit organization, institution of higher education, individual), the Authority and the Contractor agree to take the necessary actions to provide, through FTA, those rights in that invention due the Federal Government as described in U.S. Department of Commerce regulations, "Rights to Inventions Made by Nonprofit Organizations and Small Business Firms Under Government Grants, Contracts and Cooperative Agreements," 37 C.F.R. Part 401.
 - (3) The Contractor also agrees to include the requirements of this clause in each subcontract for experimental, developmental, or research work financed in whole or in part with Federal assistance provided by FTA.

30. PATENT INDEMNITY

- a. If the amount of this Contract is in excess of \$10,000, the Contractor shall indemnify the Authority and its officers, agents, and employees against liability, including costs, for infringement of any United States letters patent arising out of the manufacture or delivery of supplies under this Contract. The foregoing indemnity shall not apply unless the Contractor shall have been informed as soon as practicable by the Authority of the suite or action alleging such infringement, and shall have been given such opportunity as is afforded by applicable laws, rules, or regulations to participate in the defense thereof; and further, such indemnity shall not apply to:
- (1) an infringement resulting from compliance with specific written instructions of the Contracting Officer directing a change in the supplies to be delivered or in the materials or equipment to be used, or directing a manner or performance of the Contract not normally used by the Contractor;
 - (2) an infringement resulting from addition to, or change in, such supplies or components furnished which addition or change was made subsequent to delivery or performance by the Contractor; or
 - (3) a claimed infringement which is settled without the consent of the Contractor, unless required by final decree of court of competent jurisdiction.

31. PAYMENTS

- a. The Contractor shall be paid, upon the submission of proper invoices or vouchers, the prices stipulated herein for supplies delivered and accepted or services rendered and accepted, less deductions, if any, as specified.

- b. For those contracts which exceed \$100,000 and to which Appendix 'B' applies, the failure to perform in accordance with the said Appendix may result in partial or full suspension of payment and/or progress payments.
- c. If the Contractor meets his goal as required by Appendix 'B' of this contract titled Disadvantaged/Women Business Enterprise (DBE/WBE) or if the Contractor demonstrates that every reasonable effort has been made to meet its goal, the Contractor shall be presumed to be in compliance with said Appendix. But, if the Contracting Officer finds the Contractor not to be in compliance with said Appendix, the progress of the work shall also be deemed to be unsatisfactory and there shall be retained from payment (or progress payments) made to the Contractor pursuant to this Article of the General Provisions an amount equal to the DBE/WBE participation in the Contract. Additionally, if the Contractor fails to submit monthly DBE reports, the Contracting Officer may suspend payment (or progress payments) until such time as the monthly reports have been submitted and accepted by the Authority.

32. PAYMENT DEDUCTIONS - NONCOMPLIANCE WITH DBE REQUIREMENTS

- (a) For federally funded contracts that exceed \$100,000 and to which the Disadvantage Business Enterprise (DBE) Requirements (Appendix B) apply, the failure to perform in accordance with requirements of Appendix B may result in a partial or full suspension of payment, including progress payments, if applicable.
- (b) If the Contractor is found to be in noncompliance with the DBE requirements of Appendix B, the progress of the work shall also be deemed to be unsatisfactory, and an amount equal to the DBE participation in the Contract shall be retained from payment (or progress payments, if any) made to the Contractor.
- (c) If the Contractor fails to submit the required monthly DBE reports, the Contracting Officer may suspend payment (or progress payments) until such time as the monthly reports are submitted and accepted by the Authority.

33. PRICE REDUCTION FOR DEFECTIVE COST OR PRICING DATA — PRICE ADJUSTMENTS

- a. This article shall become operative only with respect to any modification of this Contract which involves aggregate increases and/or decreases in costs plus applicable profits in excess of \$100,000 unless the modification is priced on the basis of adequate competition, established catalog or market prices of commercial items sold in substantial quantities to the general public, or prices set by law or regulation. The right to price reduction under this article is limited to defects in data relating to such modification.
- b. If any price, including profit, or fee, negotiated in connection with any price adjustment under this Contract was increased by any significant sums because:
 - (1) The Contractor furnished cost or pricing data which was not complete, accurate and current as certified in the Contractor's Certificate of Current Cost or Pricing Data;
 - (2) A subcontractor, pursuant to the articles of this Contract entitled SUBCONTRACTOR COST OR PRICING DATA or SUBCONTRACTOR

COST OR PRICING DATA--PRICE ADJUSTMENTS or any subcontract clause therein required, furnished cost or pricing data which was not complete, accurate and current as certified in the subcontractor's Certificate of Current Cost or Pricing Data;

- (3) A subcontractor or prospective subcontractor furnished cost or pricing data which was required to be complete, accurate and current and to be submitted to support a subcontract cost estimate furnished by the Contractor but which was not complete, accurate and current as of the date certified in the Contractor's Certificate of Current Cost or Pricing Data; or
- (4) The Contractor or a subcontractor or prospective subcontractor furnished any data, not within (1) or (3) above, which was not accurate, as submitted; the price shall be reduced accordingly and the Contract shall be modified in writing as may be necessary to reflect such reduction. However, any reduction in the Contract price due to defective subcontract data of a prospective subcontractor, when the subcontract was not subsequently awarded to such subcontractor, will be limited to the amount (plus applicable overhead and profit markup) by which the actual subcontract, or the actual cost to the Contractor, if there was no subcontract, was less than the prospective subcontract cost estimate submitted by the Contractor, provided that the actual subcontract price was not affected by defective cost or pricing data.

NOTE: Since the Contract is subject to reduction under this article by reason of defective cost or pricing data submitted in connection with certain subcontracts, it is expected that the Contractor may wish to include an article in each such subcontract, requiring the subcontractor to appropriately indemnify the Contractor. However, the inclusion of such an article and the terms thereof are matters for negotiation and agreement between the Contractor and the subcontractor and are not binding upon the Authority. It is also expected that any subcontractor subject to such indemnification will generally require substantially similar indemnification for defective cost or pricing data required to be submitted to his lower tier subcontractors.

34. PRICING OF ADJUSTMENTS

- a. When costs are a factor in any determination of a Contract price adjustment pursuant to the CHANGES AND CHANGED CONDITIONS article or any other provision of this Contract, such costs shall be in accordance with the Subpart 31.1 of the Federal Acquisition Regulations (48 CFR 31.1).
- b. Notwithstanding any interpretation of the aforementioned contract cost principles and procedures to the contrary, the Authority will not be liable for interest, however represented, on or as a part of any claim, request, proposal or adjustment, including equitable adjustments, whether said claim, request, proposal or adjustment, including equitable adjustments, arises under the Contract or otherwise.
- c. Where general and administrative expense is recoverable as part of any pricing adjustment under this contract, the adjustment shall be based on the relationship between the Contractors' total general and administrative expenses allowable under FAR cost principles for all construction-type operations during the fiscal or calendar year covering the actual performance period of the work included in this pricing adjustment, and the Contractor's total cost input (excluding General and

Administrative costs) for construction-type operations during the same period, expressed as a percentage, applied to the direct and overhead contract costs included in the pricing adjustment.

35. RESPONSIBILITY FOR INSPECTION

Notwithstanding the requirements for any Authority inspection and test contained in Specifications applicable to this Contract, except where specialized inspections or tests are specified for performance solely by the Authority, the Contractor shall perform or have performed the inspections and tests required to substantiate that the supplies and services provided under the Contract conform to the Drawings, Specifications and Contract requirements.

36. RETENTION OF DOCUMENTS

Except where this Contract specifically requires otherwise, the Contractor shall retain for a period of three (3) years from final payment, all research and supporting documentation, work papers and other documents, whether written or electronic, used in the performance of services for this Contract.

37. RIGHTS IN TECHNICAL DATA

- a. The Authority shall have the right to use, duplicate or disclose technical data, which includes computer software, in whole or in part, in any manner and for any purpose whatsoever, and to have or permit others to do so:
 - (1) Any manuals, instructional materials prepared for installation, operation, maintenance or training purposes;
 - (2) Technical data pertaining to end items, components or processes which were prepared for the purpose of identifying sources, size, configuration, mating and attachment characteristics, functional characteristics and performance requirements ("form, fit and function" data; e.g., specification control drawings, catalog sheets, outline drawing; except that for computer software it means data identifying source, functional characteristics, and performance requirements but specifically excludes the source code, algorithm, process, formulae, and flow charts of the software);
 - (3) Other technical data which has been, or is normally furnished without restriction by the Contractor or subcontractor;
 - (4) Other specifically described technical data which the parties have agreed will be furnished without restriction.

- b. The Authority shall have the right to use, duplicate, or disclose technical data other than that defined in paragraph a. in whole or in part, with the express limitation that such technical data shall not, without the written permission of the party furnishing such technical data, be
 - (1) released or disclosed in whole or in part outside the Authority,
 - (2) used in whole or in part by the Authority for manufacture, or

- (3) used by a party other than the Authority except for emergency repair or overhaul work only, by or for the Authority where the item or process concerned is not otherwise reasonably available to enable timely performance of the work; provided, that the release or disclosure thereof outside the Authority shall be made subject to a prohibition against further use, release or disclosure.

- c. Technical data provided in accordance with the provisions of paragraph b. shall be identified by a legend which suitably recites the aforesaid limitation. Nothing herein shall impair the right of the Authority to use similar or identical data acquired from other sources.

- d. The term technical data as used in this article means technical writing, computer software, sound recordings, pictorial reproductions, drawings, or other graphic representations and works of a technical nature, whether or not copyrighted, which are specified to be delivered pursuant to this Contract. The term does not include financial reports, cost analyses, and other information incidental to Contract administration. Computer software as used in this article means computer programs, computer data bases, and documentation thereof.

- e. Material covered by copyright:
 - (1) The Contractor agrees to and does hereby grant to the Authority, and to its officers, agents and employees acting within the scope of their official duties, a royalty-free, nonexclusive and irrevocable license throughout the world for Authority purposes to publish, translate, reproduce, deliver, perform, dispose of, and to authorize others so to do, all technical data now or hereafter covered by copyright.

 - (2) No such copyrighted matter shall be included in technical data furnished hereunder without the written permission of the copyright owner for the Authority to use such copyrighted matter in the manner above described.

 - (3) The Contractor shall report to the Authority (or higher-tier contractor) promptly and in reasonable written detail each notice or claim of copyright infringement received by the Contractor with respect to any technical data delivered hereunder.

- f. Relation to patents: Nothing contained in this article shall imply a license to the Authority under any patent, or be construed as affecting the scope of any license or other right otherwise granted to the Authority under any patent.

- g. Any dispute under this article shall be subject to the Disputes article of this contract.

- h. Notwithstanding any other payment provision in this contract, the Contracting Officer may retain from payment up to 10 percent of the contract price until final delivery and acceptance of the technical data defined in this article and as required to be furnished by the contract specification.

38. ROYALTY INFORMATION

- a. When the response to this solicitation contains costs or charges for royalties totaling more than \$250, the following information shall be furnished with the offer, proposal, or quotation on each separate item of royalty or license fee:
- (1) Name and address of licensor;
 - (2) Date of license agreement;
 - (3) Patent numbers, patent application serial numbers or other basis on which the royalty is payable;
 - (4) Brief description, including any part or model numbers of each contract item or component on which the royalty is payable;
 - (5) Percentage or dollar rate of royalty per unit;
 - (6) Unit price or Contract item;
 - (7) Number of units; and
 - (8) Total dollar amount of royalties.
- b. In addition, if specifically requested by the Contracting Officer prior to execution of the Contract, a copy of the current license agreement and identification of applicable claims of specific patents shall be furnished.

39. SEAT BELT USE POLICY

The contractor agrees to comply with terms of Executive Order No. 13043 "Increasing Seat Belt Use in the United States" and is encouraged to include those requirements in each subcontract awarded for work relating to this contract.

40. SENSITIVE SECURITY INFORMATION

The contractor must protect, and take measures to assure that its subcontractors at each tier protect, "sensitive information" made available during the course of administering an Authority contract or subcontract in accordance with 49 U.S.C. Section 40119(b) and implementing DOT regulations, "Protection of Sensitive Security Information," 49 CFR Part 15, and with 49 U.S.C. Section 114(s) and implementing Department of Homeland Security regulations, "Protection of Sensitive Security Information," 49 CFR Part 1520.

41. STOP WORK ORDER

- a. The Contracting Officer may, at any time, by written order to the Contractor, require the Contractor to stop all, or any part of the work called for by this Contract for a period of 90 days after the order is delivered to the Contractor, and for any further period to which the parties may agree. Any such order shall be specifically identified as a STOP WORK ORDER issued pursuant to this article. Upon receipt of such an order, the Contractor shall forthwith comply with its terms and take all reasonable steps to minimize the incurrence of costs allocable to the work covered by the order during the period of work stoppage. Within a period of 90 days after a stop work

order is delivered to the Contractor, or within any extension of that period to which the parties shall have agreed, the Contracting Officer shall either:

- (1) Cancel the stop work order, or
 - (2) Terminate the work covered by such order as provided in the TERMINATION FOR CONVENIENCE article of this Contract.
- b. If a stop work order issued under this article is cancelled or the period of the order or any extension thereof expires, the Contractor shall resume work. An equitable adjustment shall be made in the delivery schedule or Contract price, or both, and the Contract modified in writing accordingly, if:
- (1) The stop work order results in an increase in the time required for, or in the Contractor's cost properly allocable to, the performance of any part of this Contract, and
 - (2) The Contractor asserts a claim for such adjustment within 30 days after the end of the period of work stoppage; provided that, if the Contracting Officer decides the facts justify such action, he may receive and act upon any such claim asserted at any time prior to final payment under this Contract.
- c. If a stop work order is not cancelled and the work covered by such order is terminated for the convenience of the Authority, the reasonable costs resulting from the stop work order shall be allowed in arriving at the termination settlement.

42. SUBCONTRACT PAYMENTS

- a. The Contractor shall, under this contract, establish procedures to ensure timely payment of amounts due pursuant to the terms of their subcontracts. The Contractor shall pay each subcontractor for satisfactory performance of its contract, no later than ten (10) days from the date of the Contractor's receipt of payment from the Authority for work by that subcontractor. The Contractor shall also release, within ten (10) days of satisfactory completion of all work required by the subcontractor, any retention withheld from the subcontractor.
- b. The Contractor shall certify on each payment request to the Authority that payment has been or will be made to all subcontractors in accordance with paragraph a above. The Contractor shall notify the contracting officer or other delegated authority representative with each payment request, of any situation in which scheduled subcontractor payments have not been made.
- c. If a subcontractor alleges that the Contractor has failed to comply with this provision, the Contractor agrees to support any Authority investigation, and, if deemed appropriate by the Authority, to consent to remedial measures to ensure subcontractor payment that is due.
- d. The Contractor agrees that the Authority may provide appropriate information to interested subcontractors who want to determine the status of Authority payments to the Contractor.

- e. Nothing in this provision is intended to create a contractual obligation between the Authority and any subcontractor or to alter or affect traditional concepts of privity of contract between all parties.

43. SUBCONTRACTOR COST AND PRICING DATA-PRICE ADJUSTMENTS

- a. Paragraphs b. and c. of this article shall become operative only with respect to any change or other modification made pursuant to one or more provisions of this Contract which involves a price adjustment in excess of \$100,000. The requirements of this article shall be limited to such price adjustments.
- b. The Contractor shall require subcontractors hereunder to submit cost or pricing data under the following circumstances:
 - (1) prior to award of any cost-reimbursement type, incentive, or price re-determinable subcontract;
 - (2) prior to the award of any subcontract the price of which is expected to exceed \$100,000;
 - (3) prior to the pricing of any subcontract change or other modification for which the price adjustment is expected to exceed \$100,000; except in the case of (2) or (3) where the price is based on adequate price competition, established catalog or market prices of commercial items sold in substantial quantities to the general public, or prices set by law or regulation.
- c. The Contractor shall require subcontractors to certify that to the best of their knowledge and belief the cost and pricing data submitted under paragraph b. above is accurate, complete, and current as of the date of execution, which date shall be as close as possible to the date of agreement on the negotiated price of the Contract modification.
- d. The Contractor shall insert the substance of this clause including this paragraph d. in each subcontract which exceeds \$100,000.

44. TERMINATION

- a. The performance of work under this Contract may be terminated by the Authority in accordance with this article in whole, or from time to time in part, whenever the Contracting Officer shall determine that such termination is in the best interest of the Authority. Any such termination shall be effected by delivery to the Contractor of a Notice of Termination specifying the extent to which performance of work under the contract is terminated, and the date upon which such termination becomes effective.
- b. After receipt of a Notice of Termination, and except as otherwise directed by the Contracting Officer, the Contractor shall:
 - (1) Stop work under the Contract on the date and to the extent specified in the Notice of Termination;
 - (2) Place no further orders or subcontracts for materials, services, or facilities, except as may be necessary for completion of such portion of the work under the Contract which is not terminated;

- (3) Terminate all orders and subcontracts to the extent that they relate to the performance of work terminated by the Notice of Termination.
 - (4) Assign to the Authority, in the manner, at the time, and to the extent directed by the Contracting Officer, all of the rights, title, and interests of the Contractor under the orders and subcontracts so terminated, in which case the Authority shall have the right, in its discretion, to settle or pay any or all claims arising out of the termination of such orders and subcontracts;
 - (5) Settle all outstanding liabilities and all claims arising out of such termination of orders and subcontracts, with the approval or ratification of the Contracting Officer, to the extent he may require, which approval or ratification shall be final for all the purposes of this article;
 - (6) Transfer title to the Authority and deliver in the manner, at the times, and to the extent, if any, directed by the Contracting Officer:
 - (a) the fabricated or unfabricated parts, work in process, completed work, supplies, and other material produced as a part of, or acquired in connection with the performance of the work terminated by the Notice of Termination, and
 - (b) the completed or partially completed plans, drawings, information and other property which, if the Contract had been completed, would have been required to be furnished to the Authority;
 - (7) Use his best efforts to sell, in the manner, at the times, to the extent, and at the price or prices directed or authorized by the Contracting Officer, any property of the type referred to in paragraph 6. above; provided, however, that the Contractor
 - (a) shall not be required to extend credit to any purchaser, and
 - (b) may acquire any such property under the conditions prescribed by and at a price or prices approved by the Contracting Officer. And, provided further, that the proceeds of any such transfer or disposition shall be applied in reduction of any payments to be made by the Authority to the Contractor under this Contract or shall otherwise be credited to the price or cost of the work covered by the Contractor or paid in such other manner as the Contracting Officer may direct;
 - (8) Complete performance of such part of the work as shall not have been terminated by the Notice of Termination; and
 - (9) Take such action as may be necessary, or as the Contracting Officer may direct, for the protection and preservation of the property related to this Contract which is in the possession of the Contractor and in which the Authority has or may acquire an interest.
- c. At any time after expiration of the plant clearance period, as defined in Subpart 45.6 of the Federal Acquisition Regulations (48 CFR 45.6), as the definition may be amended from time to time, the Contractor may submit to the Contracting Officer a

list, certified as to quantity and quality, of any or all items of termination inventory not previously disposed of, exclusive of items the disposition of which has been directed or authorized by the Contracting Officer, and may request the Authority to remove such items or enter into a storage agreement covering them. Not later than 15 days thereafter, the Authority will accept title to such items and remove them or enter into a storage agreement covering the same. Provided, that the list submitted shall be subject to verification by the Contracting Officer upon removal of the items or, if the items are stored, within 45 days from the date of submittal of the list and any necessary adjustment to correct the list as submitted shall be made prior to final settlement.

- d. After receipt of a Notice of Termination, the Contractor shall submit to the Contracting Officer his termination claim, in the form and with certification prescribed by the Contracting Officer. Such claims shall be submitted promptly but in no event later than one year from the effective date of termination, unless one or more extensions in writing are granted by the Contracting Officer upon request of the Contractor made in writing within such one-year period or authorized extension thereof. However, if the Contracting Officer determines that the facts justify such action, he may receive and act upon any such termination claim at any time after such one-year period or any extension thereof. Upon failure of the Contractor to submit his termination claim within the time allowed, the Contracting Officer may, subject to any review required by the contracting agency's procedures in effect as of the date of execution of this Contract, determine, on the basis of information available to him, the amount, if any, due the Contractor by reason of the termination and shall thereupon pay to the Contractor the amount so determined.
- e. Subject to the provisions of paragraph d., and subject to any review required by the contracting agency's procedures in effect as of the date of execution of this Contract, the Contractor and the Contracting Officer may agree upon the whole or any part of the amount or amounts to be paid to the Contractor by reason of the total or partial termination of work pursuant to this article, which amount or amounts may include a reasonable allowance for profit on work done. Provided, that such agreed amount or amounts, exclusive of settlement costs, shall not exceed the total Contract price as reduced by the amount of payments otherwise made and as further reduced by the Contract price of work not terminated. The Contract shall be amended accordingly, and the Contractor shall be paid the agreed amount. Nothing in paragraph f. of this article, prescribing the amount to be paid to the Contractor in the event of failure of the Contractor and the Contracting Officer to agree upon the whole amount to be paid to the Contractor by reason of the termination of work pursuant to this article, shall be deemed to limit, restrict, or otherwise determine or affect the amount or amounts which may be agreed upon to be paid to the Contractor pursuant to this paragraph e.
- f. In the event of the failure of the Contractor and the Contracting Officer to agree as provided in paragraph e. upon the whole amount to be paid the Contractor by reason of the termination of work pursuant to this article, the Contracting Officer shall, subject to any review required by the contracting agency's procedures in effect as of the date of execution of this Contract, determine, on the basis of information available to him, the amount if any, due the Contractor by reason of the termination and shall pay to the Contractor the amounts determined as follows:
 - (1) For completed supplies accepted by the Authority [or sold or acquired as provided in paragraph b. (7) above] and not theretofore paid for a sum

equivalent to the aggregate price for such supplies computed in accordance with the price or prices specified in the Contract, appropriately adjusted for any saving of freight or other charges;

- (2) The total of:
 - (a) The costs incurred in the performance of the work terminated, including initial costs and preparatory expense allocable thereto, but exclusive of any costs attributable to supplies paid or to be paid for under paragraph f. (1) hereof;
 - (b) The cost of settling and paying claims arising out of the termination of work under subcontracts or orders, as provided in paragraph b. (5) above, which are properly chargeable to the terminated portion of the contract (exclusive of amounts paid or payable on account of supplies or materials delivered or services furnished by subcontractors or vendors prior to the effective date of the Notice of Termination, which amounts shall be included in the costs payable under (a) above; and
 - (c) A sum, as profit on (a), above, determined by the Contracting Officer pursuant to Section 49.202 of the Federal Acquisition Regulations (48 CFR 49.202), in effect as of the date of execution of this contract, to be fair and reasonable. Provided, however, that if it appears that the Contractor would have sustained a loss on the entire Contract had it been completed, no profit shall be included or allowed under this subparagraph (d) and an appropriate adjustment shall be made reducing the amount of the settlement to reflect the indicated rate of loss; and
- (3) The reasonable costs of settlement, including accounting, legal, clerical, and other expenses reasonably necessary for the preparation of settlement claims and supporting data with respect to the terminated portion of the Contract and for the termination and settlement of subcontracts thereunder, together with reasonable storage, transportation, and other costs incurred in connection with the protection or disposition of property allocable to this Contract.
- (4) The total sum to be paid to the Contractor under (1) and (2) of this paragraph f. shall not exceed the total Contract price as reduced by the amount of payments otherwise made and as further reduced by the Contract price of work not terminated. Except for normal spoilage, and except to the extent that the Authority shall have otherwise expressly assumed the risk of loss, there shall be excluded from the amounts payable to the Contractor as provided in f. (1) and (2) (a) above, the fair value, as determined by the Contracting Officer, of property which is destroyed, lost, stolen, or damaged so as to become undeliverable to the Authority, or to a buyer pursuant to paragraph b. (7).
- g. Costs claimed, agreed to, or determined pursuant to paragraphs d., e. and f. of this article shall be in accordance with the applicable contract cost principles and procedures in Subpart 31.1 of the Federal Acquisition Regulations (48 CFR 31.1) in effect on the date of this Contract.

- h. The Contractor shall have the right to appeal, under the DISPUTES article of this Contract from any determination made by the Contracting Officer under paragraph d. or f. above, except that, if the Contractor has failed to submit his claim within the time provided in paragraph d. above and has failed to request extension of such time, he shall have no such right of appeal. In any case where the Contracting Officer has made a determination of the amount due under paragraph d. or f. above, the Authority shall pay to the Contractor the following:
- (1) if there is on right of appeal hereunder or if no timely appeal has been taken, the amount so determined by the Contracting Officer; or
 - (2) if an appeal has been taken, the amount finally determined on such appeal.
- i. In arriving at the amount due the Contractor under this article there shall be deducted
- (1) all unliquidated advance or other payments on account theretofore made to the Contractor, applicable to the terminated portion of this Contract;
 - (2) any claim which the Authority may have against the Contractor in connection with this Contract; and
 - (3) the agreed price for, or the proceeds of sale of, any materials, supplies, or other things acquired by the Contractor or sold, pursuant to the provisions of this article, and not otherwise recovered by or credited to the Authority.
- j. If the termination hereunder be partial, prior to the settlement of the terminated portion of this Contract, the Contractor may file with the Contracting Officer a request in writing for an equitable adjustment of the price or prices specified in the Contract relating to the continued portion of the Contract (the portion not terminated by the Notice of Termination), and such equitable adjustment as may be agreed upon shall be made in such price or prices.
- k. The Authority may from time to time, under such terms and conditions as it may prescribe, make partial payments and payments on account against costs incurred by the Contractor in connection with the terminated portion of this Contract whenever in the opinion of the Contracting Officer the aggregate of such payments shall be within the amount to which the Contractor will be entitled hereunder. If the total of such payments is in excess of the amount finally agreed or determined to be due under this article, such excess shall be payable by the Contractor to the Authority upon demand, together with interest computed at the rate of six percent per annum for the period from the date such excess payment is received by the Contractor to the date on which such excess is repaid to the Authority; provided, however, that no interest shall be charged with respect to any such excess payment attributable to a reduction in the Contractor's claim by reason of retention or other disposition of termination inventory until 10 days after the date of such retention or disposition, or such later date as determined by the Contracting Officer by reasons of the circumstances.
- l. Unless otherwise provided for in this Contract, or by applicable statute, the Contractor, from the effective date of termination and for a period of three years after final settlement under this Contract, shall preserve and make available to the Authority at all reasonable times at the office of the Contractor but without direct charge to the Authority, all his books, records, documents, and other evidence

bearing on the costs and expenses of the Contractor under this Contract and relating to the work terminated hereunder, or, to the extent approved by the Contracting Officer, photographs, micro photographs, or other authentic reproductions thereof.

45. TITLE AND RISK OF LOSS

- a. Unless this Contract specifically provides for earlier passage of title, title to supplies covered by this Contract shall pass to the Authority upon formal acceptance, regardless of when or where the Authority takes physical possession.
- b. (1) Unless this Contract specifically provides otherwise, risk of loss of or damage to supplies covered by this Contract shall remain with the Contractor until, and shall pass to the Authority upon:
 - (a) Delivery of the supplies to a carrier, if transportation is FOB origin;
 - (b) Acceptance by the Authority or delivery of possession of the supplies to the Authority at the destination specified in this Contract, whichever is later, if transportation is FOB destination.
- (2) Notwithstanding b. (1) above, the risk of loss of or damage to supplies which so fail to conform to the Contract as to give a right of rejection shall remain with the Contractor until cure or acceptance, at which time (1) above shall apply.
- c. Notwithstanding b. above, the Contractor shall not be liable for loss of or damage to supplies caused by the negligence of officers, agents, or employees of the Authority acting within the scope of their employment.

46. VARIATION IN QUANTITY

No variation in the quantity of any item called for by this Contract will be accepted unless such variation has been caused by conditions of loading, shipping, or packing, or allowances in manufacturing processes, and then only to the extent, if any, specified elsewhere in this Contract.

47. WALSH-HEALEY PUBLIC CONTRACTS ACT

If this Contract is for the manufacture or furnishing of materials, supplies, articles, or equipment in an amount which exceeds or may exceed \$10,000 and is subject to the Walsh-Healey Public Contracts Act, as amended (41 U.S.C. 35-45), the following terms and conditions apply:

- (a) All stipulations required by the Act and regulations issued by the Secretary of Labor (41 CFR Chapter 50) are incorporated by reference. These stipulations are subject to all applicable rulings and interpretations of the Secretary of Labor that are now, or may be hereafter, be in effect.
- (b) All employees whose work relates to this contract shall be paid not less than the minimum wage prescribed by regulations issued by the Secretary of Labor (41 CFR 50-202.2). Learners, student learners, apprentices, and handicapped worker may be employed at less than

the prescribed minimum wage (see 41 CFR 50-202.3) to the same extent that such employment is permitted under Section 14 of the Fair Labor Standards Act (41 U.S.C. 40).

SUPPLEMENTAL PROVISIONS REQUIRED IN FEDERALLY FUNDED CONTRACTS

48. ACCESS TO THIRD PARTY CONTRACT RECORDS

- a. The Contractor agrees to provide the Authority, the FTA Administrator, the Comptroller General of the United States or any of their authorized representatives access to any books, documents, papers and records of the Contractor which are directly pertinent to this contract for the purposes of making audits, examinations, excerpts and transcriptions. The Contractor also agrees, pursuant to 49 CFR. 633.17 to provide the FTA Administrator or his authorized representatives including any PMO Contractor access to Contractor's records and construction sites pertaining to a major capital project, defined at 49 U. S. C. 5302(a)1, which is receiving federal financial assistance through the programs described at 49 U. S. C. 5307, 5309 or 5311.
- b. The Contractor agrees to permit any of the foregoing parties to reproduce by any means whatsoever or to copy excerpts and transcriptions as reasonably needed.
- c. The Contractor agrees to maintain all books, records, accounts and reports required under this contract for a period of not less than three years after the date of termination or expiration of this contract, except in the event of litigation or settlement of claims arising from the performance of this contract, in which case the Contractor agrees to maintain same until the Authority, the FTA Administrator, the Comptroller General, or any of their duly authorized representatives, have disposed of all such litigation, appeals, claims or exceptions related thereto. Reference 49 CFR 18.39(i)(11).

49. BUY AMERICA

The contractor agrees to comply with 49 U.S.C. 5323(j) and 49 C.F.R. Part 661, which provide that Federal funds may not be obligated unless steel, iron, and manufactured products used in FTA-funded projects are produced in the United States, unless a waiver has been granted by FTA or the product is subject to a general waiver. General waivers are listed in 49 C.F.R. 661.7, and include final assembly in the United States for 15 passenger vans and 15 passenger wagons produced by Chrysler Corporation, and microcomputer equipment and software. Separate requirements for rolling stock are set out at 49 U.S.C. 5323(j)(2)(C) and 49 C.F.R. 661.11. Rolling stock must be assembled in the United States and have a 60 percent domestic content.

50. CARGO PREFERENCE

The Contractor agrees:

- a. To utilize privately owned United States-Flag commercial vessels to ship at least 50 percent of the gross tonnage (computed separately for dry bulk carriers, dry cargo liners, and tankers) involved, whenever shipping any equipment, materials, or commodities pursuant to this Contract to the extent such vessels are available at fair and reasonable rates for United States-Flag commercial vessels.

- b. To furnish within 20 working days following the date of loading for shipments originating within the United States, or within 30 working days following the date of loading for shipments originating outside the United States, a legible copy of a rated, "on-board" commercial ocean bill-of-lading in English for each shipment of cargo described in paragraph (a) above to WMATA (through the Contractor in the case of a subcontractor's bills-of-lading) and to the Office of Cargo Preference, Maritime Administration (MAR-590), 400 Seventh Street SW, Washington, DC 20590.
- c. To include these requirements in all subcontracts issued pursuant to this Contract when the subcontract may involve the transport of equipment, material, or commodities by ocean liner.

51. CLEAN AIR

- a. The Contractor agrees to comply with all applicable standards, orders or regulations issued pursuant to the Clean Air Act, as amended, 42 U. S. C. §§ 7401 et seq. The Contractor agrees to report each violation to the Authority and understands and agrees that the Authority will, in turn, report each violation as required to FTA and the appropriate EPA Regional Office.
- b. The Contractor also agrees to include these requirements in each subcontract exceeding \$100,000 financed in whole or in part with Federal assistance provided by FTA.

52. CLEAN WATER

- a. The Contractor agrees to comply with all applicable standards, orders or regulations issued pursuant to the Federal Water Pollution Control Act, as amended, 33 U. S. C. 1251 et seq. The Contractor agrees to report each violation to the Authority and understands and agrees that the Authority will, in turn, report each violation as required to assure notification to FTA and the appropriate EPA Regional Office.
- b. The Contractor also agrees to include these requirements in each subcontract exceeding \$100,000 financed in whole or in part with Federal assistance provided by FTA.

53. CONTRACTS INVOLVING FEDERAL PRIVACY ACT REQUIREMENTS

The following requirements apply to the Contractor and its employees that administer any system of records on behalf of the Federal Government under any contract:

- (1) The Contractor agrees to comply with, and assures the compliance of its employees with, the information restrictions and other applicable requirements of the Privacy Act of 1974, 5 U.S.C. § 552a. Among other things, the Contractor agrees to obtain the express consent of the Federal Government before the Contractor or its employees operate a system of records on behalf of the Federal Government. The Contractor understands that the requirements of the Privacy Act, including the civil and criminal penalties for violation of that Act, apply to those individuals involved, and that failure to comply with the terms of the Privacy Act may result in termination of the underlying contract.

- (2) The Contractor also agrees to include these requirements in each subcontract to administer any system of records on behalf of the Federal Government financed in whole or in part with Federal assistance provided by FTA.

54. ENERGY CONSERVATION

- a. The Contractor agrees to comply with mandatory standards and policies relating to the energy efficiency which are contained in the applicable state energy conservation plan issued in compliance with the Energy Policy and Conservation Act.
- b. The Contractor agrees to include the requirements of this clause in all subcontracts under this contract.

55. CHANGES TO FEDERAL REQUIREMENTS

- a. Contractor shall at all times comply with all applicable FTA regulations, policies, procedures and directives, including without limitation those listed directly or by reference in the Agreement (Form FTA MA (14) dated October 1, 2007) between the Authority and FTA, as they may be amended or promulgated from time to time during the term of this contract. Contractor's failure to so comply shall constitute a materiel breach of this contract.
- b. The Contractor agrees to include this clause in each subcontract financed in whole or in part with Federal Assistance provided by FTA. It is further agreed that the clause shall not be modified, except to identify the subcontractor who will be subject to its provisions.

56. FLY AMERICA

The Contractor agrees to comply with 49 U. S. C. 40118 (the "Fly America" Act) in accordance with the General Services Administration's regulations at 41 CFR Part 301-10, which provide that recipients and subrecipients of Federal funds and their contractors are required to use U. S. Flag carriers for U. S. Government-financed international air travel and transportation of their personal effects or property, to the extent such service is available, unless travel by foreign air carrier is a matter of necessity, as defined by the Fly America Act. The Contractor shall submit, if a foreign air carrier was used, an appropriate certification or memorandum adequately explaining why service by a U. S. flag carrier was not available or why it was necessary to use a foreign air carrier and shall, in any event, provide a certificate of compliance with the Fly America requirements. The Contractor agrees to include the requirements of this section in all subcontracts that may involve international air transportation.

57. DEBARMENT OR SUSPENSION

- a. The Contractor is bound by its certification contained in its offer to the Authority that neither the Contractor, its principals, or affiliates, are excluded or disqualified, as defined at 49 C.F.R. 29.940 and 29.945. The certification is a material representation of fact, relied upon by the Authority in entering into this Contract. If it is later determined that the Contractor knowingly rendered an erroneous certification, in addition to remedies available to the Authority, the Federal Government may pursue available remedies, including but not limited to suspension and/or debarment. The Contractor agrees to comply with the requirements of 49 C.F.R. 29, Subpart C, throughout the term of this Contract.

- b. The Contractor agrees to include this requirement in all subcontracts at all tiers under this Contract.

58. INCORPORATION OF FEDERAL TRANSIT ADMINISTRATION (FTA) TERMS

- a. The preceding provisions include, in part, certain Standard Terms and Conditions required by the U.S. Department of Transportation (DOT), whether or not expressly set forth in the preceding contract provisions. All contractual provisions required by DOT, as set forth in FTA Circular 4220.1F or any revisions thereto, are hereby incorporated by reference. Anything to the contrary herein notwithstanding, all DOT or FTA mandated terms shall be deemed to control in the event of a conflict with other provisions contained in this Agreement. The Contractor shall not perform any act, fail to perform any act, or refuse to comply with any Authority requests which would cause the Authority to be in violation of the FTA terms and conditions.
- b. The Contractor agrees to include this clause in each subcontract financed in whole or in part with Federal assistance provided by FTA. It is further agreed that the clause shall not be modified, except to identify the subcontractor who will be subject to the provisions.

59. LOBBYING

- a. The Contractor is bound by its certification contained in its offer to the Authority regarding the use of federal or non-federal funds to influence, or attempt to influence any Federal officer or employee regarding the award, execution, continuation, or any similar action of any Federal grant or other activities as defined in 31 U.S.C. 1352, 49 CFR Part 19, or 49 C.F.R. Part 20. The Contractor agrees to comply with this requirement throughout the term of the Contract.
- b. The Contractor agrees to include these requirements in all subcontracts at all tiers under this Contract.

60. NO FEDERAL GOVERNMENT OBLIGATIONS TO THIRD PARTIES

- a. The Authority and the Contractor acknowledge and agree that, notwithstanding any concurrence by the Federal Government in or approval of the solicitation or award of this contract, absent the express written consent by the Federal Government, the Federal Government is not a party to this contract and shall not be subject to any obligations or liabilities to the Authority, Contractor or any other party (whether or not a party to that contract) pertaining to any matter resulting from the underlying contract.
- b. The Contractor agrees to include this clause in each subcontract financed in whole or in part with Federal Assistance provided by FTA. It is further agreed that the clause shall not be modified, except to identify the subcontractor who will be subject to its provisions.

61. FALSE STATEMENTS OR CLAIMS CIVIL AND CRIMINAL FRAUD

- a. The Contractor acknowledges that the provisions of the Program Fraud Civil Remedies Act of 1986, as amended, 31 U. S. C. 3801 et seq and U. S. DOT Regulations, "Program Fraud Civil Remedies," 49 C.F. R. Part 31, apply to its actions

pertaining to this Project. Upon execution of the underlying contract, the Contractor certifies and affirms the truthfulness and accuracy of any statement it has made, it makes, it may make, or causes to be made, pertaining to the underlying contract or the FTA assisted project for which this contract work is being performed. In addition to other penalties that may be applicable, the Contractor further acknowledges that if it makes or causes to be made, a false, fictitious, or fraudulent claim, statement, submission, or certification, the Federal Government reserves the right to impose the penalties of the Program Fraud Civil Remedies Act of 1986 on the Contractor to the extent the Federal Government deems appropriate.

- b. The Contractor also acknowledges that if it makes, or causes to be made, a false, fictitious, or fraudulent claim, statement, submission, or certification to the Federal Government under a contract connected with a project that is financed in whole or in part with Federal assistance originally awarded by FTA under the authority of 49 U. S. C. 5307, the Government reserves the right to impose the penalties of 18 U. S. C. 1001 and 49 U. S. C. 5307 (n)(1) on the Contractor, to the extent the Federal Government deems appropriate.
- c. The Contractor agrees to include this clause in each subcontract financed in whole or in part with Federal assistance provided by FTA. It is further agreed that the clause shall not be modified, except to identify the subcontractor who will be subject to the provisions.

62. RECOVERED MATERIALS

- a. The Contractor agrees to comply with all the requirements of Section 6002 of the Resource Conservation and Recovery Act (RCRA) as amended (42 U. S. C. 6962), including but not limited to the regulatory provisions of 40 CFR Part 247, and Executive Order 12873, as they apply to the procurement of the items designated in Subpart B of 40 CFR Part 247.
- b. The Contractor also agrees to include these requirements in each subcontract financed in whole or in part with Federal assistance provided by FTA.

63. RIGHTS IN DATA AND COPYRIGHTING - FTA

- a. The term "subject data" used in this section means recorded information, whether or not copyrighted, that is delivered or specified to be delivered under this contract. The term includes graphic or pictorial delineation in media such as drawings or photographs; text in specifications or related performance or design-type documents; machine forms such as punched cards, magnetic tape, or computer memory printouts; and information retained in computer memory. Examples include, but are not limited to: computer software, engineering drawings and associated lists; specifications, standards, process sheets, manuals, technical reports, catalog item identifications, and related information. The term "subject data" does not include financial reports, cost analyses, and similar information incidental to Project administration.
- b. The following restrictions apply to all subject data first produced in the performance of this contract.
 - (1) Except for its or WMATA's own internal use, the Contractor may not publish or reproduce subject data in whole or in part, or in any manner or form, nor

may the Contractor authorize others to do so, without the written consent of the U.S. Government, until such time as the Government may have either released or approved the release of such data to the public; this restriction on publication, however, does not apply to Agreements with academic institutions.

- (2) In accordance with 49 C.F.R. § 18.34 and 49 C.F.R. 19.36, the Government reserves a royalty-free, non-exclusive and irrevocable license to reproduce, publish, or otherwise use, and to authorize others to use, the following subject data for Federal Government purposes:
 - (a) Any subject data developed under this contract whether or not a copyright has been obtained; and
 - (b) Any rights of copyright to which the contractor purchases ownership with Federal assistance.
- c. When the Federal Transit Administration (FTA) provides financial assistance for a planning, research, development, or a demonstration project, it is FTA's general intention to increase mass transportation knowledge, rather than limit the benefits of the Project to participants in the Project. Therefore, unless FTA determines otherwise, the Contractor agrees that, in addition to the rights set forth in subsection (b)(2) of this clause, FTA may make available to any FTA recipient, subrecipient, third party contractor, or third party subcontractor, either FTA's license in the copyright to the subject data derived under this contract or a copy of the subject data first produced under this contract. If this contract is not completed for any reason whatsoever, all data developed under this contract shall become subject data as defined in subsection a. of this clause and shall be delivered as the Government may direct.
- d. Unless prohibited by state law, the Contractor agrees to indemnify, save, and hold harmless WMATA and the Government, their officers, agents, and employees acting within the scope of their official duties against any liability, including costs and expenses, resulting from any willful or intentional violation by the contractor of proprietary rights, copyrights, or right of privacy, arising out of the publication, translation, reproduction, delivery, use, or disposition of any data furnished under this Contract. The Contractor shall not be required to indemnify WMATA and the Government for any such liability arising out of the wrongful acts of employees or agents of WMATA and the Government.
- e. Nothing contained in this section on rights in data shall imply a license to WMATA or the Government under any patent or be construed as affecting the scope of any license or other right otherwise granted to WMATA or the Government under any patent.
- f. The requirements of subsections b. and c., do not apply to material furnished by the Authority to the Contractor and incorporated in the work carried out under the contract provided that the Contractor identifies the incorporated material at the time of delivery of the work.
- g. Any dispute under this clause shall be subject to the Disputes clause of this contract.

- h. Notwithstanding any other payment provision in this contract, the Contracting Officer may retain from payment up to 10 percent (10 %) of the contract price until final delivery and acceptance of the subject data defined in this clause and as required to be furnished by the contract specification.

PART II, SECTION 2 - SPECIAL PROVISIONS

PART II, SECTION 2 - SPECIAL PROVISIONS

1. PERIOD OF PERFORMANCE

The period of performance is 180 calendar days commencing on the date of award. Be advised that **contract period is subject to the availability of “Federal Funds” Approved by FTA and the WMATA Board of Directors in its Operation Budget.**

2. DELIVERY SCHEDULE

- a. The Authority requires delivery of hardware and software from date of award of contract.

3. OPTION QUANTITIES

- a. The Authority has the unilateral right to extend the contract by exercising the option or options (as applicable) subject to all terms and conditions herein.
- b. The Authority may exercise the option(s) (if any) by written notice to the Contractor prior to commencement of the option period; provided, that the Authority shall give the contractor a preliminary notice of its intent to extend at least 30 days before the contract expires. The preliminary notice does not commit the Authority to an extension.

4. AVAILABILITY OF FUNDS FOR THE NEXT FISCAL YEAR

Funds are not presently available for performance under this contract beyond the fiscal year which ends June 30, 2014 (FY14). The Authority’s obligation for performance of this contract beyond that date is contingent upon the availability of funds from which payment for contract purposes can be made. No legal liability on the part of the Authority for any payment may arise for performance under this contract until funds are made available to the Contracting Officer for performance and until the Contractor receives notice of availability, to be confirmed in writing, by the Contracting Officer. Any option exercised by the Authority which will be performed in whole or in part in a subsequent fiscal year is subject to availability of funds in the subsequent fiscal year is subject to availability of funds in the subsequent fiscal year and will be governed by the terms of this Article.

5. PRICING

Prices on the Price Schedule Sheets submitted must include all associated costs, including but not limited to, travel, markups, overhead, and profit.

6. PAYMENT TERMS

- a. Discounts for prompt payment will not be considered in the evaluation of offers. However, any offered discount will form a part of the award, and will be taken if payment is made within the discount period indicated in the offer by the Offeror.
- b. Partial payments are authorized upon receipt of supplies or services, acceptance by the COTR, and a properly executed invoice.

7. BILLING AND PAYMENT

- a. Payment will be made after receipt of a properly completed invoice. Mail original and one copy of all invoices to Office of Accounting, WMATA, 6th Floor, 600 Fifth Street, NW, Washington DC 20001. Also mail one copy of each invoice to the Contracting Officer's Technical Representative (COTR).
- b. Invoices shall contain the following information: date, contract and order number (if any), item numbers, description of supplies or services, sizes, quantities, unit prices, and extended totals. Final invoices must clearly be marked "FINAL" and cite the amount of the contract, amount previously paid, and the balance due.

8. POINT OF CONTACT

All inquiries are to be directed to:

Washington Metropolitan Area Transit Authority
Attn: Benjamin T. Kpadeh
Office of Procurement and Materials
3C-05-B
600 5th Street, NW
Washington, DC 20001
Phone: (202) 962-2478
FAX: (202) 962-2038 (Please call before you send a fax)
E-Mail: bkpadeh@wmata.com

9. F.O.B. DESTINATION

- a. The term "f.o.b. destination," as used in this clause, means:
 1. Free of expense to WMATA on board the carrier's conveyance, at a specified delivery point where the consignee's facility (plant, warehouse, store, lot, or other location to which shipment can be made) is located; and
 2. Supplies shall be delivered to the destination consignee's warehouse unloading platform, or receiving dock, at the expense of the Contractor. WMATA shall not be liable for any delivery, storage, demurrage, accessorial, or other charges involved before the actual delivery (or "constructive placement" as defined in carrier tariffs) of the supplies to the destination, unless such charges are caused by an act or order of WMATA acting in its contractual capacity. If the Contractor uses rail carrier or freight forwarder for less than carload shipments, the Contractor shall assure that the carrier will furnish tailgate delivery if transfer to truck is required to complete delivery to consignee.
- b. The Contractor shall:
 1. Pack and mark the shipment to comply with contract specification;
 2. In the absence of specifications, prepare the shipment in conformance with carrier requirements;
 3. Prepare and distribute commercial bills of lading;

4. Deliver the shipment in good order and condition to the point of delivery specified in the contract;
5. Be responsible for any loss of and/or damage to the goods occurring before receipt of the shipment by the consignee at the delivery point specified in the contract;
6. Furnish a delivery schedule and designate the mode of delivering carrier; and
7. Pay and bear all charges to the specified point of delivery.

10. CONTRACTOR PERSONNEL

- a. The Contractor shall replace employees who the Authority judges to be incompetent, careless, unsuitable or otherwise objectionable, or whose continued use is deemed contrary to the best interests of the program. The reason for replacement will be discussed between the Contractor and the Authority before a replacement request is issued. Upon receipt of a written request from the Authority, the Contractor shall proceed with the replacement unless the Contractor is able to demonstrate that the Authority's request is unreasonable. The replacement request will include the desired replacement date and the reason for the request. The Contractor shall effect the replacement in a manner that does not impact quality, cost or schedule.
- b. Contractor personnel required to work on WMATA property must obtain a WMATA vendors badge and successfully complete the mandatory safety training which must be renewed yearly. To obtain a vendors badge a signed waiver to perform a background check will be required.

10.1 Project Staffing:

The vendor shall deploy a project team made up of the following technical skill sets:

10.2 Solutions Provider Architect(s)

The Vendor shall provide at least one Architect to WMATA (two is preferred). The Architect must possess technical experience deploying the proposed solution and at least two years of experience in the following areas: TSM, RMAN and SQL backups and VMware.

Responsibilities of the Architect include:

- Certifying site readiness.
- Verifying compatibility and supported hardware/software.
- Attending status meetings, as required.
- Implementation and validation of the technical solution.

The tasks for the consultant will encompass, but not be limited ad hoc planning, design, installation and implementation activities to support the project deliverables.

11. PRE-EMPLOYMENT CRIMINAL BACKGROUND CHECK REQUIREMENT

Criminal background checks of all contractor employees working at a WMATA facility on this contract will be required pursuant to Metro Policy/Instruction 7.40/0, Background Screenings and Metro Policy/Instruction 6.10/5, Metro Employee Identification Cards, Section 5.04. Eligibility for access to WMATA property will be based on WMATA's pre-employment

Criminal Background Check criteria. WMATA will provide the contractor employees with background check consent forms that the contractor's employees must complete and sign. The forms will require the contractor employees to appear in person, provide their full legal names, including middle initials if applicable, as well as their Social Security numbers, in addition to other information that will be necessary to conduct the background checks. The operating hours are Monday through Friday from 7:30AM to 3:30PM except holidays. Upon receipt of the completed, signed forms, WMATA will conduct background checks including criminal court searches and Social Security Number verifications of the contractor employees. If there is derogatory information that would disqualify a contractor employee from receiving a badge to access WMATA property, the Contractor and its employee will be notified that the background check failed. The completed forms are secured in a locked file cabinet and are destroyed one year after the expiration date on the contractor employee's badge. These background checks are expected to take one (1) business day for processing. The contractor employee must allow sufficient time for completion. The background check is free of charge.

Background checks are conducted to promote a safe work environment and to protect our company's most important assets: the people we serve and the people with whom we serve. This enables WMATA management to make prudent decisions and to maintain a high quality workforce. Contractor employees who successfully complete the background checks are eligible to enter WMATA property once they are issued a contractor badge. Contractor employees who do not authorize background checks or whose background checks are unsatisfactory will not be granted contractor badges or access to WMATA property. The records generated by these background checks that contain private information will not be disclosed unless disclosure is required under the PARP/Privacy Policies.

12. MOST FAVORED CUSTOMER

The Contractor shall voluntarily provide the Authority with the benefits of any more favorable terms it has, or negotiates, with any organization or facility whose circumstances and operations are substantially the same as those of the Authority.

13. CONDITIONS AFFECTING THE WORK

The Contractor shall be responsible for having taken steps reasonably necessary to ascertain the nature and extent of the work, and the general and local conditions which can affect the work or the cost thereof. Any failure by the Contractor to do so will not relieve the Contractor from responsibility for successfully performing work without additional expense to the Authority. The Authority assumes no responsibility for any understanding or representations concerning conditions made by any of its officers or agents prior to the execution of this Contract, unless such understanding or representations are expressly stated in the Contract.

14. WARRANTY

All the Hardware and Software that will be purchased from this solicitation will have three (3) years comprehensive warranty for parts, labor and support.

15. IINDEMNIFICATION

1. Contractor shall indemnify, defend and hold harmless the Authority, its directors, officers, employees and agents, from all liabilities, obligations, damages, penalties, claims, costs, charges and expenses (including reasonable attorney's fees), of whatsoever kind and nature for

injury, including personal injury or death of any person or persons, and for loss or damage to any property, including the property of the Contractor and the Authority, occurring in connection with, or in any way arising out of the use, occupancy and performance of the work and/or any acts in connection with activities to be performed under this contract, unless the loss or damage is due to the sole negligence of the Authority. Nothing in the preceding sentence shall be deemed to relieve Contractor from ultimate liability for any obligation of Contractor under this Contract.

2. Contractor shall indemnify, defend and hold harmless the Authority, its directors, officers, employees and agents, against any and all claims, liabilities, losses, demands, damages, penalties, costs, charges, remedial costs, environmental claims, fees or other expenses including attorneys' fees, related to, arising from or attributable to any effluent or other hazardous waste, residue, contaminated soil or other similar material discharged from, removed from, or introduced on, about or under the job site; provided, however, that the foregoing indemnity does not apply to loss or damage due to preexisting conditions, whether known or unknown.
3. If any action or proceeding relating to the indemnification required is brought against the Authority, then upon written notice from the Authority to the Contractor, the Contractor shall, at the Contractor's expense, resist or defend such action or proceeding by counsel approved by the Authority in writing, such approval not to be unreasonably withheld, but no approval of counsel shall be required where the cause of action is resisted or defended by counsel of any insurance carrier obligated to resist or defend the same. The Authority reserves the right to use its own counsel under this indemnity at Contractor's sole cost and expense.
4. Contractor understands and agrees that it is Contractor's responsibility to provide indemnification to the Authority pursuant to this Section. The provision of insurance, while anticipated to provide a funding source for this indemnification, is in addition to any indemnification requirements and the failure of Contractor's insurance to fully fund any indemnification shall not relieve the Contractor of any obligation assumed under this indemnification.

16. GENERAL INSURANCE REQUIREMENTS

Contractor shall procure, at its sole cost and expense, and shall maintain in force at all times during the term of this Contract, including the Warranty Period if applicable, the insurance outlined in the section below. All insurance companies must have an A.M. Best rating of "A-/VII" or better and be approved by the Authority. All required insurance policies must

1. State or be endorsed to provide that the coverage afforded under Contractor's policies shall apply on a primary basis and not on an excess or contributing basis with any policies that may be available to the Authority, and
2. Have self-insurance retentions or policy deductibles no greater than \$100,000, unless approved in writing by the Authority, whose approval shall not be unreasonably withheld.

Contractor shall give at least thirty (30) days prior written notice to the Authority's Office of Insurance if any required insurance policy is canceled, materially changed, or non-renewed; or if policy limits have been exhausted.

The insurance limits required herein may be met through Contractor's primary and umbrella/excess policies. Policies must be written on an occurrence basis; a claims made basis is not acceptable, except for Professional Liability.

Contractor shall furnish evidence of all required insurance prior to the start of any work on Authority property. Certificates of insurance (COI) and all applicable endorsements may be submitted to the Authority in lieu of copies of insurance policies; if Railroad Protective Liability insurance and/or Builder's Risk insurance is required, the entire insurance policy must be sent to the Authority. However, the Authority reserves the right to request copies of policies of any required insurance as denoted below. If requested by the Authority, the Contractor shall deliver to the Authority within thirty (30) days of the request, a copy of such policies, certified by the insurance carrier as being true and complete.

COIs shall 1) disclose any deductible, sublimit, self-insured retention, aggregate limit or any exclusions to the policy that materially change the coverage; 2) show the Authority as an additional insured for Commercial General Liability and Automobile Liability; 3) reference the contract number, and 4) expressly reference the inclusion of all required endorsements, including but not limited to the Additional Insured endorsement. All endorsements must include policy numbers.

Upon expiration of the policies, Contractor shall provide renewal COIs and all applicable endorsements to the Authority, with terms and limits no less favorable than the expiring insurance policies.

Evidence of insurance coverage – insurance certificates and endorsements (and the complete Railroad Protective Liability policy, if applicable) – stating the work to be performed shall be submitted to the Authority at least ten (10) business days prior to commencement of operations and from time to time at the Authority's request. Contractor shall not be allowed to proceed until the evidence of insurance has been received and approved in writing by the Authority. All evidence of insurance shall be sent to:

Washington Metropolitan Area Transit Authority
Office of Procurement, File Room 3C-02
600 5th Street, NW
Washington, DC 20001

With a copy to:

Washington Metropolitan Area Transit Authority
Office of Insurance, Room 8F
600 5th Street, NW
Washington, DC 20001

Required Insurance

1. **Commercial General Liability Insurance** with minimum limits of \$2,000,000 per occurrence/aggregate, written on an occurrence form. If the required minimum limits can only be met when applying an umbrella/excess liability policy, the umbrella/excess liability policy must follow form of the underlying policy and be extended to "drop down" to become primary in the event the primary limits are reduced or aggregate limits are exhausted. XCU coverage (explosion, collapse, and underground hazards) shall be included if any of the work involves excavation or blasting. Terrorism coverage shall also be included. The Contractual Liability Exclusion (applicable to work to be performed within 50 feet of railroad property) must be removed. The coverage under such an insurance policy or policies shall be maintained throughout the contract period and for three (3) years following acceptance of the work if the CGL insurance is written on a claims made form.

WMATA shall be named an Additional Insured with respect to this agreement on all certificates of insurance (COI), and the Additional Insured endorsement shall include completed operations and be submitted to the Authority.

2. **Workers' Compensation Insurance** meeting the statutory requirements of the jurisdiction where the work will be performed, including Employer's Liability coverage with minimum limits of \$1,000,000 each accident or disease.
3. **Business Automobile Liability Insurance** with minimum combined single limits of \$2,000,000 per occurrence covering contractor against claims for bodily injury and property damage arising out of the ownership, maintenance or use of any owned, hired, or non-owned motor vehicle. WMATA shall be added as an additional insured on the policy.
4. **Technology Errors and Omissions Insurance** with minimum limits of \$5,000,000 per claim covering actual or alleged negligent acts, errors or omissions committed by the Contractor in the performance of activities under this agreement, regardless of the type of damages. If the insurance is on a claims made basis, Contractor shall maintain continuous insurance coverage during the term of this agreement. The policy retroactive date must coincide with or precede the effective date of Contractor's services under the agreement and shall continue until the termination of the agreement. The policy must allow for reporting of circumstances or incidents that might give rise to future claims, and an extended reporting period of at least one year must be purchased in the event ongoing coverage is not maintained.
5. **Network/Information Security & Privacy Liability** coverage providing protection against liability for privacy breaches, system breach, denial or loss of service introduction, implantation, or spread of malicious software code and unauthorized access to or use of computer systems with minimum limits of \$2,000,000 each claim.

17. **BOND REQUIREMENTS**

OPTIONAL – N/A

- a. Within 10 calendar days after the prescribed forms are presented for signature to the proposer to whom award is made, a written Contract and Attachments on the forms provided in Section _____ shall be executed and delivered to the Contracting Officer or other delegated Authority Representative, together with a performance bond and payment bond if applicable if the Contract price is \$100,000 or more, each with good and sufficient surety or sureties acceptable to the Authority. Corporations executing the bonds as sureties must be among those appearing on the Treasury Department's list of approved sureties and must be acting within the limitations set forth therein. The penal sums of such bonds shall be as follows:

- (1) Performance Bond:

The penal sum of the performance bond shall equal 100 percent of the Contract price.

- (2) Payment Bond:

- (a) When the Contract price is \$1,000,000 or less, the penal sum of the payment bond shall be 50 percent of the Contract price.

- (b) When the Contract price is in excess of \$1,000,000 but not more than \$5,000,000, the penal sum shall be 40 percent of the Contract price.
 - (c) When the Contract price is more than \$5,000,000, the penal sum shall be \$2,500,000.
- b. Failure to furnish: In the event the required bonds are not furnished as specified, the Contracting Officer or other delegated Authority Representative may not issue the Notice To Proceed and no payment will be made to the Contractor until the required bonds are furnished.

18. PROPOSAL SECURITY

OPTIONAL – CO Determinations – NOT APPLICABLE

The proposal security is five percent of the proposal price. The proposal security form and the five percent of the proposal price should be submitted with the price proposal.

19. LAWS AND REGULATIONS

Each Offeror shall be responsible to fully inform themselves of the requirements for and to comply with any applicable State of Maryland, Commonwealth of Virginia, District of Columbia, Federal and jurisdictional laws and regulations governing the service to be provided under the contract. Further, each contractor shall be responsible to obtain, at its own cost and expense, any and all licenses/permits required to transact business in any political jurisdictions to be serviced.

20. PRIME CONTRACTOR DBE RESPONSIBILITIES

- a. If the contract value is over \$100,000, the prime contractor will be responsible for submitting a monthly report of the status of its DBE subcontractors as outlined in Appendix B.
- b. Reports shall be submitted monthly to the Authority Representative, who in turn, will forward a copy to the Office of Procurement and Materials, DBE Branch, Jackson Graham Building, 600 Fifth Street NW, Washington DC 20001.

21. FEDERAL/LOCAL/STATE SALES TAX

- a. Pursuant to Article XVI., Paragraph 78., of the Washington Area Metropolitan Transit Authority Compact, as adopted by the State of Maryland, the District of Columbia, and the Commonwealth of Virginia, with the authorization and consent of the Congress of the United States, the Authority has been accorded exemption from taxes as follows:

“the Authority and the Board shall not be required to pay taxes or assessments upon any of the property acquired by it or under its jurisdiction, control, possession or supervision, or upon its activities in the operation and maintenance of any transit facility or upon any revenues therefrom, and the property and income derived therefrom shall be exempted from all Federal, State, District of Columbia, municipal, and local taxation. This exemption

shall include without limitation, all motor vehicle license fees, sales taxes and motor fuel taxes.”

- b. It has been the practice of the District of Columbia to apply the Authority’s tax exempt status to certain purchases of materials required under Authority construction contracts and acquired by Contractor for physical incorporation into the project work. This has not been the practice in either Maryland or Virginia. The Authority does not represent or warrant that the District of Columbia practice applies to this project or, if it does, that it will continue in effect during the term of this project. It is the responsibility of the Contractor to determine its liability for any and all taxes applicable to this project. Assessment or payment of taxes by the Contractor, including taxes resulting from changes in existing laws or the application thereof or of new or additional taxes, shall not constitute the basis for an increase in the Contract price, except as otherwise allowed under Section 00779, FEDERAL, STATE AND LOCAL TAX.
- c. By submission of its proposal, the proposer certifies that none of the taxes as to which the Authority is exempt are included in its proposal price(s) or the final Contract Price. In the event that the Authority learns that any taxes to which the Authority is exempt are included in the final Contract Price, the Authority shall be entitled to a reduction in the Contract Price reflecting such amount and a refund of monies paid related to such taxes, plus applicable interest.

22. CONTRACTING OFFICER’S TECHNICAL REPRESENTATIVE (COTR)

- a. The work will be conducted under the general direction of the Contracting Officer. Authority will be delegated to the Contracting Officer's Technical Representative (COTR) to take the following actions;
 - (1) Act as the principal point of contact with the contractor. Submit a copy of each item of incoming correspondence and a copy of any enclosures shall also be submitted to the Contract Administrator;
 - (2) Approve in writing the contractor’s progress schedule and submittals when required;
 - (3) Inspect the work for compliance with the contract;
 - (4) Review and approve invoices and payment estimates. Forward invoices and receipts to accounting. Bring to the attention of the Contracting Officer any significant discrepancies in, or disputes concerning, contractor invoices of payments. In those cases requiring release of final retained percentages of payment, the COTR will make his recommendations in writing to the Contracting Officer;
 - (5) Coordinate correspondence with the Contract Administrator if its importance significantly impacts the contractual terms and obligations;
 - (6) Evaluate the contractor’s technical letters and proposals for the Contracting Officer;
 - (7) Advise the Contracting Officer of potential problems that may affect contract performance;

- (8) Advise the Contracting Officer whenever the COTR has reason to believe that the contractual not-to-exceed amount will be exceeded;
 - (9) Prepare the Authority estimate for Proposed Contract Modifications. Participate in negotiations of modifications;
 - (10) Approve, in writing, the contractor's progress schedule when required.
 - (11) Receive from the contractor, monthly, if applicable, DBE status reports and forward them to the Office of Procurement and Materials, DBE Branch;
 - (12) Receive from the contractor the Certified Payroll Reports and prepare a log sheet indicating the following: (1) name of the contractor and subcontractor; (2) the contract number; (3) the certified payroll number (number for the payroll for the project starting with the number 1); (4) the time frame of the payroll period (i.e. 1/21/11-2/3/11); (5) the Statement of Compliance date (first page of the report); and (6) the date the report was received by WMATA;
 - (13) Maintain a comprehensive file record of documents and correspondence concerning contract activities and actions;
 - (14) Provide the Contract Administrator with a written notification after all supplies/services have been received with a statement that the COTR is not aware of any open issues that would preclude closeout of the contract and that the contract is ready for closeout. Return the file, containing all records, correspondence, etc., to the Contract Administrator;
 - (15) Execute Standard Form 1420, which contains a detailed performance evaluation of the contractor. Note that if, there is one or more categories in which the contractor is deemed unsatisfactory, these evaluations must be provided to the contractor for comment; and
 - (16) Provide the Contract Administrator with a written request (and requisition) to exercise option(s) (if any) a minimum of 90 days prior to the time established in the contract for exercise of the option.
- b. There are certain actions which are reserved for only the Contracting Officer. They are:
- (1) Approval of contract modification proposals and/or other unilateral actions.
 - (2) Issuance of written orders to stop and/or resume work under Article 10, "Stop Work Orders", of the General Provisions.
 - (3) Negotiation with the Contractor for adjustment of contract price and/or time.
 - (4) The COTR is not authorized to render final decision under the DISPUTES article of the General Provisions.
 - (5) The COTR is not authorized to issue Termination Notices pursuant to the terms of this contract.

- c. The presence or absence of the COTR or his inspectors shall not relieve the Contractor from any requirements of the contract.

23. HAZARDOUS MATERIAL IDENTIFICATION AND MATERIAL SAFETY DATA

- a. The Contractor agrees to submit a Material Safety Data Sheet (Department of Labor Form OSHA-20), as prescribed in Federal Standard No. 313B, for all hazardous material 5 days before delivery of the material, whether or not listed in Appendix A of the Standard. This obligation applies to all materials delivered under this contract which involve exposure to hazardous materials or items containing these materials.
- b. "Hazardous material," as used in this clause, is as defined in Federal Standard No. 313B, in effect on the date of this contract.
- c. Neither the requirements of this clause nor any act or failure to act by the Authority shall relieve the Contractor of any responsibility or liability for the safety of Authority, Contractor, or subcontractor personnel or property.
- d. Nothing contained in this clause shall relieve the Contractor from complying with applicable Federal, state, and local laws, codes, ordinances, and regulations (including the obtaining of licenses and permits) in connection with hazardous material.
- e. The Authority's rights in data furnished under this contract with respect to hazardous material are as follows:
 - (1) To use, duplicate and disclose any data to which this clause is applicable. The purposes of this right are to (i) apprise personnel of the hazards to which they may be exposed in using, handling, packaging, transporting, or disposing of hazardous material (ii) obtain medical treatment for those affected by the material; and (iii) have others use, duplicate, and disclose the data for the Authority for these purposes.
 - (2) To use, duplicate, and disclose data furnished under this clause, in accordance with subparagraph (e)(1) above, in precedence over any other clause of this contract providing for rights in data.
 - (3) That the Authority is not precluded from using similar or identical data acquired from other sources.
 - (4) That the data shall not be duplicated, disclosed, or released outside the Authority, in whole or in part for any acquisition or manufacturing purpose, if the following legend is marked on each piece of data to which this clause applies -

"This is furnished under Authority Contract No. and shall not be used, duplicated, or disclosed for any acquisition or manufacturing purpose without the permission of This legend shall be marked on any reproduction of this data."
(End of legend)
 - (5) That the Contractor shall not place the legend or any other restrictive legend on any data which (i) the Contractor or any subcontractor previously delivered to the Authority without limitations or (ii) should be delivered without

limitations under the conditions specified in the clause Rights in Technical Data.

- f. The Contractor shall insert this clause, including this paragraph with appropriate changes in the designation of the parties, in subcontracts at any tier (including purchase designations or purchase orders) under this contract involving hazardous material.

24. SPECIAL DELIVERY INSTRUCTIONS

This solicitation provides for the following deliverables for each data center:

Hardware:

1. Cloud Storage Tiering Appliance in JGB data center
2. Cloud Storage Tiering Appliance in CTF data center

Planning:

1. Detailed Technical Requirements (Bi-weekly)
2. Updated Technical Architecture (Bi-weekly)
3. Updated Data Architecture (Bi-weekly)
4. Documentation for implementation (Bi-weekly)
5. Overall Project Plan updates (Weekly)

Design:

1. Topology drawings
2. Map the solution as per the approved proposal

Services:

Jackson Graham Building (JGB): 600 5th Street, NW, Washington, DC 20001

1. Install and configure the hardware
2. Integrate the proposed solution within the current environment.
3. Carve up storage to be presented as iSCSI targets
4. Configure cloud storage tiering capabilities
5. Backup entire configuration

Carmen Turner Facility (CTF) TF: 3500 Penny Drive, Landover, MD 20785

1. Install and configure the hardware
2. Integrate the proposed solution within the current environment.
3. Carve up storage to be presented as iSCSI targets
4. Configure cloud storage tiering capabilities
5. Backup entire configuration

25. INSPECTION, TESTING AND ACCEPTANCE/VALIDATION

- Verify the functionality of the cloud storage tiering appliance disaster recovery capabilities

- Verify the connectivity of the cloud storage tiering appliance in JGB and CTF data centers
- Test and validate replication operations
- Validate business continuity and DR of the newly installed infrastructure

26. FIRST ARTICLE

OPTIONAL – NOT APPLICABLE

- a. If required by the technical specifications, the Contractor shall deliver one (1) unit to the Authority for first article (pre-production sample) tests. The shipping documentation shall contain this contract number and the Lot/Item identification. The Characteristics that the first article must meet and the testing requirements are specified elsewhere in this contract.
- b. Within 10 days after the Authority receives the first article, the Contracting Officer shall notify the Contractor, in writing, of the conditional approval, approval, or disapproval of the first article. The notice of conditional approval or approval shall not relieve the Contractor from complying with all requirements of the specifications and all other terms and conditions of this contract. A notice of conditional approval shall state any further action required of the Contractor. A notice of disapproval shall cite the reasons for the disapproval.
- c. If the first article is disapproved, the Contractor, upon Authority request, shall submit an additional first article for testing. After each request, the Contractor shall make any necessary changes, modifications, or repairs to the first article or select another first article for testing. All costs related to these tests are to be borne by the Contractor, including any and all costs for additional test following a disapproval. The Contractor shall furnish any additional first article to the Authority under the terms and conditions and within the time specified by the Authority. The Authority shall act on this first article within the time limit specified in paragraph (b) above. The Authority reserves the right to require an equitable adjustment of the contract price for any extension of the delivery schedule or for any additional costs to the Authority related to these tests.
- d. If the Contractor fails to deliver any first article on time, or the Contracting Officer disapproves any first article, the Contractor shall be deemed to have failed to make delivery within the meaning of the Defaults clause of this contract.
- e. Unless otherwise provided in the contract, the Contractor—
 - (1) May deliver the approved first article as a part of the contract quantity, provided it meets all contract requirements for acceptance and was not consumed or destroyed in testing; and
 - (2) Shall remove and dispose of any first article from the Authority test facility at the Contractor's expense.
- f. If the Authority does not act within the time specified in paragraph (b) or (c) above, the Contracting Officer shall, upon timely written request from the Contractor, equitably adjust under the Changes clause of this contract the delivery or performance dates and/or the contract price, and any other contractual term affected by the delay.

- g. The Contractor is responsible for providing operating and maintenance instructions, spare parts support, and repair of the first article during any first article test.
- h. Before first article approval, the acquisition of materials or components for, or the commencement of production of, the balance of the contract quantity is at the sole risk of the Contractor. Before first article approval, the costs thereof shall not be allocable to this contract for (1) progress payments, or (2) termination settlements if the contract is terminated for the convenience of the Authority.
- i. The COTR will inspect the first article (pre-production sample) against the specification and shop drawings as well as test its fit in the field. A written report will be forwarded to the contractor in accordance with (b) above.

27. ORGANIZATIONAL CONFLICT OF INTEREST

Unless specifically exempted from the conditions of this provision by the Contracting Officer, any Authority contractor, subcontractor, subsidiary, or other entity which is legally related and which develops or drafts specifications, requirements, statements of work, request for proposals, will be excluded from competing for the directly ensuing procurement.

28. RIGHTS IN TECHNICAL DATA - UNLIMITED

[This article, when used, supersedes General Provision Article No. 37, "Rights in Technical Data"].

- a. The Authority or any third party designated by the Authority to assist it in the administration of this contract or the inspection or verification of the product produced under this contract, shall have the right to use, duplicate or disclose technical data, which includes computer software, in whole or in part, in any manner and for any purpose whatsoever, and to have or permit others to do so:
 - 1. Any manuals, instructional materials prepared for installation, operation, maintenance or training purposes;
 - 2. Technical data pertaining to end items, components or processes which were prepared for the purpose of identifying sources, size, configuration, mating and attachment characteristics, functional characteristics and performance requirements ("form, fit and function" data; e.g., specification control drawings, catalog sheets, outline drawing; except for the computer software it means data identifying source, functional characteristics, and performance requirements but specifically excludes the source code, algorithm, process, formulae, and flow charts of the software);
 - 3. Other technical data which has been, or is normally furnished without restriction by the Contractor or subcontractor;
 - 4. Other specifically described technical data which the parties have agreed will be furnished without restriction;
 - 5. All computer software regardless of whether it is technical data as defined in this Article 28, including the source code, algorithm, process, formulae, and flow charts, which is developed or materially modified by the Contractor for the Authority or for which the Authority is required by federal law or regulation

- to provide a royalty-free, irrevocable and nonexclusive license to the federal government.
- b. The Authority shall have the right to use, duplicate, or disclose technical data other than that defined in paragraph a. in whole or in part, with the express limitation that such technical data shall not, without the written permission of the party furnishing such technical data, be
 - 1. Released or disclosed in whole or in part outside the Authority,
 - 2. Used in whole or in part by the Authority for manufacture, or
 - 3. Used by a party other than the Authority except for: (i) emergency repair or overhaul, (ii) where the item or process concerned is not otherwise reasonably available to the Authority to enable timely performance of the work, or (iii) administration of this contract or the inspection or verification of the product produced under this contract where the third party has a written contract with the Authority to perform these efforts. In all cases described in this subsection, the release or disclosure outside of the Authority shall be subject to a written prohibition against further use, release or disclosure by the party receiving the technical data.
 - c. Technical data provided in accordance with the provisions of paragraph b. shall be identified by a legend which suitably recites the aforesaid limitation. Nothing herein shall impair the right of the Authority to use similar or identical data acquired from other sources.
 - d. Where any item is purchased as a separate line item in the contract, that purchase includes all integral parts of that item, including any computer software, source codes, algorithms, processes, formulae, and flow charts. As such, the Authority has full rights to use, duplicate or disclose any or all parts of the item, including computer software, in whole or in part, in any manner and for any purpose whatsoever, and to have or permit others to do so. Should disclosure of the computer software be required only under this paragraph, then the Contracting Officer may waive the provisions of this paragraph if he certifies in writing that the item is commercially available from multiple sources and the product from any of those sources will be fully compatible with existing Authority property.
 - e. The term technical data as used in this article means technical writing, computer software, sound recordings, pictorial reproductions, drawings, or other graphic representations and works of a technical nature, whether or not copyrighted, which are specified to be delivered pursuant to this Contract. The term does not include financial reports, cost analyses, and other information incidental to Contract administration. Computer software as used in this article means computer programs, computer data bases, and documentation thereof.
 - f. Material covered by copyright:
 - (1) The Contractor agrees to and does hereby grant to the Authority, and to its officers, agents and employees acting within the scope of their official duties, a royalty-free, nonexclusive and irrevocable license throughout the world for Authority purposes to publish, translate, reproduce, deliver, perform, dispose

of, and to authorize others so to do, all (i) technical data and (ii) computer software covered by Article 28.a.(5) now or hereafter covered by copyright.

- (2) No such copyrighted matter shall be included in (i) technical data or (ii) computer software covered by Article 28.a.(5) furnished hereunder without the written permission of the copyright owner for the Authority to use such copyrighted matter in the manner above described.
 - (3) The Contractor shall report to the Authority (or higher-tier contractor) promptly and in reasonable written detail each notice or claim of copyright infringement received by the Contractor with respect to any (i) technical data or (ii) computer software covered by Article 28.a.(5) provided to the Authority.
- g. Relation to patents: Nothing contained in this article shall imply a license to the Authority under any patent, or be construed as affecting the scope of any license or other right otherwise granted to the Authority under any patent.
 - h. Any dispute under this article shall be subject to the Disputes article of this contract.
 - i. Notwithstanding any other payment provision in this contract, the Contracting Officer may retain from payment up to 10 percent of the contract price until final delivery and acceptance of the technical data defined in this article and as required to be furnished by the contract specification.

29. LIQUIDATED DAMAGES

- a. The Contractor understands that if it fails to complete portion of and/or all of the work as described herein Period of Performance of these Special Provisions, the Authority will suffer damages which have been estimated and are specified below:
- b. The Contactor agrees that if it does not complete the work within the specified Period of Performance, then the Contractor shall pay to the Authority as liquidated damages, Termination for Default, Damages for Delay, the sums per calendar days as separate damages for each specified completion requirement in 1 above.

30. FORCE MAJEURE CLAUSE

The Contractor's right to proceed shall not be so terminated nor the Contractor charged with resulting damage under the following circumstances:

- a. If the delay in performing this work arises from unforeseeable causes beyond the control and without the fault or negligence of the Contractor, including, but not restricted to, acts of God, acts of the public enemy, acts of the Authority in its contractual capacity, fires, floods, epidemics, quarantine restrictions, strikes, freight embargoes, unusually severe weather, or delays of subcontractors or suppliers at any tier arising from causes other than normal weather beyond the control and without the fault or negligence of both the Contractor and such subcontractors or suppliers.
- b. The rights and remedies of the Authority provided in this Section are in addition to any other rights and remedies provided by law or under this Contract.

31. SITE VISIT/INSPECTION

Offeror must provide and maintain sufficient facilities that will allow them to adequately perform contract functions as specified herewith. WMATA may make site visits prior to contract award to examine the contractor's facilities. This will include _____ (CA TO DETERMINE) and also to verify that proper equipment, supplies, etc. are readily available. Facilities(s) must demonstrate that Offeror has the capability to perform the work described in the Scope of Services.

32. GARNISHMENT OF PAYMENTS

Payment under this contract shall be subject to any garnishment and attachment orders issued pursuant to the laws of Maryland, Virginia, and the District of Columbia, and to levies under the laws of the United States.

33. GOVERNING LAW

This contract shall be deemed to be an agreement under and shall be governed by the law of the District of Columbia, exclusive of its conflict of law principles, and the common law of the U.S. Federal contracts including precedents of the Federal Boards of Contract Appeals.

34. SAFETY REQUIREMENTS

- a. The Contractor shall be responsible for ensuring compliance with the most stringent provisions of the applicable statutes and regulations of the District of Columbia, State of Maryland, Commonwealth of Virginia or political subdivision in which the work is being performed, as well as the METRO Construction Safety Methods Manual (1984 et. seq.) issued by the Authority, and the Department of Labor OSHA standards pertaining to the safe performance of the work. In the absence of a specific Construction Industry Standard, the Contractor would be required to comply with either an established OSHA General Industry Standard, National Institute for Occupational Safety and Health (NIOSH) guidelines, American Conference of Governmental Industrial Hygienists (ACGIH) guidelines, American National Standards Institute (ANSI) guidelines, the WMATA System Safety Program Plan, the WMATA Construction Safety Methods Manual, or the Metrorail Safety Rules and Procedures Handbook. For contracts in which work is performed on, or interfaces with the Metrorail System, the Contractor shall also comply with the publication titled Metrorail Safety Rules and Procedures Handbook. Further, the Contractor shall ensure that all methods of performing the work do not involve danger to the personnel employed thereon, the public and private property, whether or not these methods are cited or indicated in the Contract documents. Should charges of violation of any of the above be issued to the Contractor in the course of the work, a copy of each charge shall be immediately forwarded to the Authority Representative.
- b. The contractor shall employ and assign full time to the work a Safety Superintendent. The Safety Superintendent shall have specialized training and experience in construction safety supervision and have a working knowledge of all OSHA regulations. He shall have the ability to develop and conduct safety training courses. He shall be familiar with industrial hygiene equipment and testing as required for the protection of all employees. The Safety Superintendent shall be employed exclusively for the purpose of supervising the safety of persons on or about the work

and the property affected thereby. The Safety Superintendent shall also be responsible for providing first aid at the site and must have a current Red Cross First Aid Certificate. If, at any time, the work site is without the services of an approved Safety Superintendent for a period of 15 calendar days or more, the work may be closed down at the discretion of the Contracting Officer. The Safety Superintendent must be acceptable to the Contracting Officer and his performance will be reviewed by the Contracting Officer on a continuing basis. If the Safety Superintendent's effectiveness is below standard, the Contractor shall provide immediate replacement at the Contracting Officer's direction. Once employed, the Safety Superintendent shall not be changed without permission of the Contracting Officer.

- c. The contractor shall provide, at the site of the work, a first aid kit which shall be fully equipped to meet the needs of the anticipated work force.
- d. The contractor shall follow all appropriate RAIL Operational Rules, OAPs, SOPs and General and Special Orders while on the operational railroad and all Start-Up Rules and Manager's Notices when in a declared start-up area.

35. LIVING WAGE

This contract is subject to the Authority's Living Wage Policy and implementing regulations. The Living Wage provision is required in all contracts for services (including construction) awarded in an amount that exceeds \$100,000 in a 12-month period.

- a. The Authority Living Wage Rate is \$13.14 per hour, and may be reduced by the contractor's per-employee cost for health insurance.
- b. The Contractor shall:
 - (1) Pay, at a minimum, the Authority Living Wage Rate, effective during the time the work is performed, to all employees who perform work under this contract, except as otherwise provided in paragraph (d) below;
 - (2) Include the Living Wage clause in all subcontractors that exceed \$15,000 in a 12-month period awarded under this contract;
 - (3) Maintain payroll records, in accordance with the retention and examination of records requirements in the General Provisions, and shall include a similar provision in affected subcontracts that requires the subcontractor to maintain its payroll records for the same length of time; and
 - (4) Submit records with each monthly invoice supporting payment of the Living Wage Rate.
- c. The Contractor shall not split or subdivide a contract, pay an employee through a third party, or treat an employee as a subcontractor or independent contractor to avoid compliance with the Living Wage provisions.
- d. Exemptions to the Living Wage provisions include:
 - (1) Contracts and agreements with higher negotiated wage rates,

- (2) Contracts that are subject to higher wage rates required by federal law or collective bargaining agreements (e.g., Davis Bacon);
 - (3) Contracts or agreements for regulated utilities;
 - (4) Emergency services to prevent or respond to a disaster or imminent threat to public health and safety; and
 - (5) Contractors who employ fewer than ten (10) employees.
- e. The Authority may adjust the Living Wage rate effective in January of each year. The adjustment will reflect the average Living Wage Rate among Metro's Compact Jurisdictions with Living Wage provisions. If after contract award the Living Wage Rate increases, the Contractor is entitled to an equitable adjustment to the rate in the amount of the increase for employees who are affected by the escalated wage.
- f. Failure to comply with the Authority's Living Wage provisions shall result in the Authority's right to exercise available contract remedies, including contract termination or debarment from future contracts.

36. METRIC SYSTEM

To the extent U.S. DOT or FTA directs, the Contractor agrees to use the metric system of measurement in its Project activities, in accordance with the Metric Conversion Act, as amended by the Omnibus Trade and Competitiveness Act, 15 U.S.C. 205a et seq; Executive Order No. 12770, "Metric Usage in Federal Government Programs," 15 U.S.C. 205a note; and applicable U.S. DOT or FTA regulations in accordance with applicable Federal directives. As practicable and feasible, the Contractor agrees to supply products and services with dimensions expressed in the metric system of measurement. Metric usage shall not be required to the extent that such use is impractical or is likely to cause significant inefficiencies or loss of markets to United States firms.

37. SEISMIC SAFETY

- a. The contractor agrees that any new building or addition to an existing building will be designed and constructed in accordance with the standards for Seismic Safety required in Department of Transportation Seismic Safety Regulations 49 CFR Part 41 and will certify to compliance to the extent required by the regulation. The contractor also agrees to ensure that all work performed under this contract including work performed by a subcontractor is in compliance with the standards required by the Seismic Safety Regulations and the certification of compliance issued on the project.
- b. The Seismic Safety requirements apply only to contracts for the construction of new buildings or additions to existing buildings.

38. RECYCLED PRODUCTS

The contractor agrees to comply with all the requirements of Section 6002 of the Resource Conservation and Recovery Act (RCRA), as amended (42 U.S.C. 6962), including but not limited to the regulatory provisions of 40 CFR Part 247, and Executive Order 12873, as they apply to the procurement of the items designated in Subpart B of 40 CFR Part 247.

39. NOTIFICATION OF FEDERAL PARTICIPATION

This project is being funded in whole or part with Federal funds.

40. WHISTLEBLOWER PROTECTION

- a. The Contractor and its subcontractors shall encourage their employees and independent contractors to report information—without fear of actual or threatened discrimination, retaliation or reprisal—that they in good faith reasonably believe is evidence of gross mismanagement; gross misuse or waste of public resources or funds; fraud; violation of law; abuse of authority in connection with the conduct of Metro operations or contracts; or a substantial and specific danger to health, security or safety. The Contractor and its subcontractors shall notify their employees that they may make reports under this paragraph to:
- (1) WMATA's Office of Inspector General (OIG), in person, in writing, through the OIG Hotline (888-234-2374) or email wmata-oig-hotline@verizon.net or by any other reasonable means;
 - (2) WMATA's Metro Transit Policy Department (MTPD), in person, by telephone (202-962-2121) or by any other reasonable means, or to the OIG, if the information constitutes a potential violation of criminal law;
 - (3) WMATA's Chief Safety Officer, in person, in writing, through the SAFE Hotline (202-249-7233) or email safety@wmata.com, or by any other reasonable means; or
 - (4) Any other official, office or agency within WMATA or outside WMATA that the employee or independent contractor reasonably believes has the authority to act on the matter.
- b. The Contractor, its employees, independent contractors and subcontractors shall cooperate with any inquiry or review by an authorized official of WMATA, or by the federal government or any other governmental entity with jurisdiction over WMATA, regarding a matter that would constitute a report under paragraph (a) or a violation of this or any whistleblower provision of this Contract, and with any enforcement or judicial proceeding arising from such inquiry or review.
- c. The Contractor and its subcontractors shall not interfere with or deny the right of any employee or independent contractor of either the Contractor or any of its subcontractors to make a report under paragraph (a). The Contractor and its subcontractors shall not recommend, take or threaten to take any action having a negative or adverse impact on any employee or independent contractor of either the Contractor or any of its subcontractors because he or she:
- (1) made or is perceived to have made a report under paragraph (a);
 - (2) sought a remedy under applicable law after making a report under paragraph (a);
 - (3) participated in or cooperated with an inquiry or review by an authorized official of Metro, or by the federal government or any other governmental entity with jurisdiction over Metro, regarding a matter that would constitute a

- report under paragraph (a) or a violation of this or any whistleblower provision of this Contract, or with an enforcement or judicial proceeding arising from such inquiry or review;
- (4) refused to obey an order that would violate law; or
 - (5) refused to work or authorize work when a hazardous safety or security condition presents an imminent danger of death or serious injury, there was no reasonable alternative to refusal, there was not sufficient time to eliminate the danger in absence of refusal and the individual, where possible, notified the Contractor or subcontractor of the condition and of the intent not to perform or authorize work.
- d. The Contractor shall include, or shall cause to be included, the substance of this section, including this paragraph (d), in its subcontracts at all tiers.
- e. The Contractor and its subcontractors shall comply with the National Transit Systems Security Act (NTSSA), which prohibits discharging, demoting, suspending, reprimanding or in any other way discriminating against an employee as a reprisal for the employee lawfully and in good faith—
- (1) reporting a hazardous safety or security condition;
 - (2) refusing to work when a hazardous safety or security condition presents an imminent danger of death or serious injury, there is no reasonable alternative to refusal, there is not sufficient time to eliminate the danger in absence of refusal and the individual, where possible, has notified the Contractor or subcontractor of the condition and of the intent to not perform work;
 - (3) refusing to authorize the use of any safety or security related equipment, track or structures, if the individual is responsible for their inspection or repair and reasonably believes they are in a hazardous safety or security condition, there is no reasonable alternative to refusal, there is not sufficient time to eliminate the danger in absence of refusal and the individual, where possible, has notified the Contractor or subcontractor of the condition and of the intent not to authorize use of hazardous equipment or infrastructure unless corrected;
 - (4) providing information for or directly assisting in an investigation of conduct that the individual reasonably believes to be in violation of federal law regarding safety, security or fraud, waste or abuse of funds intended for safety or security;
 - (5) refusing to violate or assist in violation of federal public transportation safety or security law;
 - (6) cooperating with a safety or security investigation by the U.S. Secretary of Transportation, U.S. Secretary of Homeland Security or the National Transportation Safety Board;
 - (7) furnishing information to law enforcement agencies relating to an accident or incident resulting in damage to property, injury or death; or

- (8) filing a complaint under the NTSSA or testifying regarding such complaint.
- f. The contractor shall notify the Authority of any instance, related to this Contract, of a report under paragraph (a)(1) or refusal under paragraphs (a)(2), (3) or (5).
- g. The enforcement, filing and investigation of complaints, and remedies under this section shall be governed by the NTSSA, applicable federal regulations and federal law.
- h. This section shall be interpreted in accordance with the NTSSA. If any provision is found to be in conflict with the NTSSA, the NTSSA shall govern.
- i. The Contractor shall include, or shall cause to be included, the substance of this section, including this paragraph (e), in its subcontracts at all tiers.

41. DRUG AND ALCOHOL TESTING

Contractors who perform safety-sensitive functions shall be subject to compliance with a drug and alcohol testing program according to Federal guidelines published in FTA regulations (49 CFR Part 655).

42. DAVIS-BACON AND COPELAND ANTI-KICKBACK ACTS (NOT APPLICABLE)

This contract is subject to the Davis-Bacon and Related Acts. All rulings and interpretations of the Davis-Bacon and Related Acts contained in 29 CFR parts 1, 3, and 5 are herein incorporated by reference in this contract. The Davis-Bacon Act requires contractors and subcontractors under construction contracts and subcontracts greater than \$2,000 to submit the required certified payrolls weekly.

43. PUBLIC COMMUNICATION

Contractor shall not issue communications to the media, place advertisements, nor publicize through any means the services or goods they are providing WMATA under this agreement without prior consent from the project manager following consultation with the Assistant General Manager, Customer Service, Communications & Marketing (AGM, CSCM) or her designee. Contractor shall not publish, in print or online, any communications products such as newsletters, press releases, blogs or other communications to WMATA employees without prior consent from the project manager, subsequent to approval by the AGM, CSCM. Approval of any such requests shall be at the sole discretion of WMATA and coordinated by the project manager, who will confer with CSCM and other WMATA departments as appropriate to facilitate reviews. This provision is not intended to curtail routine communications exercised in the course of business with project staff which may be required to execute deliverables under this agreement. This provision is also not intended to prohibit the contractor from making reference to prior awards in its subsequent offers.



MID-ATLANTIC PURCHASING TEAM RIDER CLAUSE

USE OF CONTRACT(S) BY MEMBERS COMPRISING Mid –Atlantic Purchasing Team COMMITTEE

Extension to Other Jurisdictions

The [issuing jurisdiction] extends the resultant contract (s), including pricing, terms and conditions to the members of the Mid-Atlantic Purchasing Team, as well as all other public entities under the jurisdiction of the United States and its territories.

Inclusion of Governmental & Nonprofit Participants (Optional Clause)

This shall include but not be limited to private schools, Parochial schools, non-public schools such as charter schools, special districts, intermediate units, non-profit agencies providing services on behalf of government, and/or state, community and/or private colleges/universities that required these good, commodities and/or services.

Notification and Reporting

The Contractor agrees to notify the issuing jurisdiction of those entities that wish to use any contract resulting from this solicitation and will also provide usage information, which may be requested. The Contractor will provide the copy of the solicitation and resultant contract documents to any requesting jurisdiction or entity.

Contract Agreement

Any jurisdiction or entity using the resultant contract (s) may enter into its own contract with the successful Contractor (s). There shall be no obligation on the party of any participating jurisdiction to use the resultant contract (s). Contracts entered into with a participating jurisdiction may contain general terms and conditions unique to that jurisdiction Including, by way of illustration and not limitation, clauses covering minority participation, non-discrimination, indemnification, naming the jurisdiction as an additional insured under any required Comprehensive General Liability policies, and venue.

Mid-Atlantic Purchasing Team:

- | | | |
|---|--|---|
| <input type="checkbox"/> Alexandria Public Schools | <input type="checkbox"/> Frederick, Maryland | <input type="checkbox"/> Northern Virginia Community College |
| <input type="checkbox"/> Alexandria Sanitation Authority | <input type="checkbox"/> Frederick County, Maryland | <input type="checkbox"/> Prince George's Community College |
| <input type="checkbox"/> Arlington County, Virginia | <input type="checkbox"/> Gaithersburg, Maryland | <input type="checkbox"/> Prince George's County, Maryland |
| <input type="checkbox"/> Arlington County Public Schools | <input type="checkbox"/> Greenbelt, Maryland | <input type="checkbox"/> Prince George's Public Schools |
| <input type="checkbox"/> Bladensburg, Maryland | <input type="checkbox"/> Herndon, Virginia | <input type="checkbox"/> Prince William County, Virginia |
| <input type="checkbox"/> Bowie, Maryland | <input type="checkbox"/> Leesburg, Virginia | <input type="checkbox"/> Prince William County Public Schools |
| <input type="checkbox"/> BRPC | <input type="checkbox"/> Loudoun County, Virginia | <input type="checkbox"/> Prince William County Service Authority |
| <input type="checkbox"/> Charles County Public Schools | <input type="checkbox"/> Loudoun County Public Schools | <input type="checkbox"/> Rockville, Maryland |
| <input type="checkbox"/> City of Fredericksburg | <input type="checkbox"/> Loudoun County Water Authority | <input type="checkbox"/> Spotsylvania County |
| <input type="checkbox"/> College Park, Maryland | <input type="checkbox"/> Manassas, Virginia | <input type="checkbox"/> Spotsylvania County Government & Schools |
| <input type="checkbox"/> District of Columbia Government | <input type="checkbox"/> City of Manassas Public Schools | <input type="checkbox"/> Stafford County, Virginia |
| <input type="checkbox"/> District of Columbia Public Schools | <input type="checkbox"/> Manassas Park, Virginia | <input type="checkbox"/> Takoma Park, Maryland |
| <input type="checkbox"/> District of Columbia Water & Sewer Auth. | <input type="checkbox"/> Maryland-National Capital Park & Planning Comm. | <input type="checkbox"/> Upper Occoquan Service Authority |
| <input type="checkbox"/> Fairfax, Virginia | <input type="checkbox"/> Maryland Department of Transportation | <input type="checkbox"/> Vienna, Virginia |
| <input type="checkbox"/> Fairfax County, Virginia | <input type="checkbox"/> Metropolitan Washington Airports Authority | <input type="checkbox"/> Washington Metropolitan Area Transit Authority |
| <input type="checkbox"/> Fairfax County Water Authority | <input type="checkbox"/> Metropolitan Washington Council of Governments | <input type="checkbox"/> Washington Suburban Sanitary Commission |
| <input type="checkbox"/> Falls Church, Virginia | <input type="checkbox"/> Montgomery College | <input type="checkbox"/> Winchester, Virginia |
| <input type="checkbox"/> Fauquier County Schools & Government | <input type="checkbox"/> Montgomery County, Maryland | <input type="checkbox"/> Winchester Public Schools |
| | <input type="checkbox"/> Montgomery County Public Schools | |

PART III TECHNICAL SPECIFICATIONS

INTRODUCTION

The purpose of this request-for-proposal (RFP) is to procure services and hardware to adopt a modern hybrid cloud storage infrastructure model that not only supports long-term backup and recovery strategies, but also provide access to cloud-based storage capacity on-demand. The desired solution should offer a highly scalable and efficient block-level cloud storage tier, and above all, full integration with on-premises storage.

This RFP is issued by Washington Metropolitan Area Transit Authority (WMATA) on behalf of the Department of Information Technology (IT), Office of Data Center and Infrastructure (DCI), hereinafter referred to as "Authorized POC". The objective of the project described in this RFP is hereinafter referred to as "Solution". The terms vendor and supplier will be used synonymously to refer to the entity responsible for providing services to WMATA.

BACKGROUND

WMATA is currently grappling with the constant explosion of data coupled with the obvious challenges tied to the traditional approach of backup and recovery. WMATA's ultimate goal is to eliminate recurring maintenance and on-going operational costs that are becoming a drain on the budget. In an effort to address these deficiencies, the WMATA IT team has decided to venture beyond the capabilities offered by the existing anachronistic data protection model.

Current Environment

The current backup environment utilizes the existing SAN infrastructure which spans across two data centers, with the Primary Site at Jackson Graham Building (JGB) at 600 5th Street NW, Washington, DC 20001 and the Secondary Site - Carmen Turner Facility (CTF) at the 3500 Pennsy Drive, Hyattsville, Maryland 20785.

The SAN infrastructure is redundant within and between data centers, and is designed to facilitate bi-directional synchronous and asynchronous data and remote backup operation across sites. The current SAN bandwidth between data centers total is 32Gbps.

SAN Fabric

A summary of the elements of the SAN fabric is below:

- Two Brocade DCX core switches with 240 ports at JGB (headquarter site)
- Two Brocade DCX core switches with 240 ports at CTF (DR site)
- Each DCX switch has four 4-gpbs Coarse Wave Division Multiplexing (CWDM) SFPs
- Various Brocade edge switches converge to these the core SAN switches

SAN Topology

- Core edge
- The switch fabrics are redundant and ***merged across sites***

SAN Storage

The SAN storage infrastructure consists of two EMC VMAX storage arrays and two EMC VNX storage arrays. Replication between the data centers is synchronous.

Primary Types of Backup at WMATA

WMATA currently uses both Veeam and Tivoli Storage Manager (TSM) to perform Enterprise backup. There are three (3) types of backups performed which are as follows:

File system Backups: All file system backups are Progressive Incremental. Backups are scheduled daily from TSM. File system Backup retention for WMATA is currently 30 days.

Database backups (RMAN): Full backups (Level 0) are performed on a weekend basis. Incremental (Level 1) are scheduled during weekdays. Log backups are performed hourly. Backups are scheduled by the Database administrator using Oracle Enterprise Manager (OEM). Backup Retention for Oracle RMAN (Recovery Manager) backups is currently set at 14 days. Oracle Database Backups are scheduled by Oracle Enterprise Manager and managed by TSM.

Virtual Environment Backups: WMATA is currently using VEEAM to backup VMware infrastructure. Backups are currently stored on Disk and later copied to tape using the TSM infrastructure. Backups are performed according to individual SLA's.

TSM Backup Overview

The TSM Portion of the Enterprise backup environment manages 400TB of data. 30% of the data managed by TSM is structured and the remaining 70% of the data is both file system data and archive. The average rate of change for data is 20% weekly. We anticipate an average growth rate of 20 % over the next 3 years.

The TSM Backup Infrastructure:

- (2) IBM P520 running AIX 6.1
- (2) Quantum Scalar i6000 Automated Tape Libraries each with 12 LTO5 Drives
- (2) Sepaton 2100 VTL (Virtual Tape Library) 170TB usable capacity
- Tape Courier (provides weekly tape rotation)
- Tivoli Storage Manager 6.3.4 on AIX
- 600 Backup clients consisting of Windows, AIX and Linux
- 70 Online Database clients (Oracle, MS-SQL)
- 4 SAN-Based backup clients
- TSM Manager (used for administering environment)

Challenges:

- 1- Cost of the backup hardware maintenance
- 2- Current VTL solution is not compatible with our available application based data deduplication
- 3- Cost of the backup hardware augmentation
- 4- Increase of TSM software licensing cost
- 5- TSM significant usage of primary storage capacity usage

Virtual Backup Environment Overview

The virtual backup environment at WMATA currently consists of 900 Virtual guests. The average rate of change is 20% weekly. The virtual backup environment is growing rapidly and anticipated to grow 150% over the next 3 years.

Veeam backup solution for virtual infrastructure at WMATA consists of 3 components.

- 1) Veeam backup server
- 2) Backup proxies
- 3) Backup repositories.

The Veeam backup server is a virtual machine running on virtual infrastructure and backup repositories consists of 3 physical Dell R720 servers. Each Dell R720 server has 18TB of local storage and 10Gbs network connectivity. The backup proxy server role has also been assigned to the same 3 Dell R270 servers which also serve as backup repositories. WMATA virtual infrastructure comprises of 900 virtual machines. These virtual machines are distributed among two sites. WMATA uses VMware vSphere for its virtual infrastructure and current environment consists of versions 4.1, 5, and 5.5. The virtual machines are running various versions of Windows (2003R2, 2008R2, 2012R2) and Linux as guest operating system. Currently Veeam manages 40 TB of data and average rate of change for data is 20% weekly. WMATA is actively virtualizing most of the physical server infrastructure thus the virtual server infrastructure environment is growing very rapidly. WMATA is anticipating a growth rate of 150% over the next 3 years.

WMATA Disaster Recovery Strategy

All primary data at JGB is stored on a Virtual Tape Library (VTL). Data written to the VTL is replicated to the DR site (CTF) over SAN. In addition, data at the primary site is copied to tape and sent offsite weekly. CTF is currently serves as the disaster recovery site for TSM.

Appendix List:

Please see Appendix A for a list of products

Please see Appendix B for the current WMATA Backup Solution

Please see Appendix C for the current WMATA Disaster Recovery Diagram

Please see Appendix D for the current SAN infrastructure diagram.

Please see Appendix E for the current LAN/WAN infrastructure diagram.

SCOPE

WMATA seeks a highly qualified and experienced contractor who can enhance our current backup and recovery strategy, and deploy a cost-effective, fail-proof block-level enterprise hybrid cloud storage solution that integrates on-premises storage devices with online cloud storage tiers. In addition, WMATA wishes to phase out both our legacy tape library and virtual tape library (VTL) hardware which will aid in reducing both hardware maintenance and software licensing costs.

This innovative solution must address current challenges, and meet WMATA’s data protection **general** requirements, while matching the desired **features**. Initially, we anticipate transferring approximately 100TB per site to the cloud storage tiering appliance.

General Requirements

- **Scalability** - *Easily expands to meet organizational demands for storage*
- **Recoverability** - *Cloud tier is optimized for efficient disaster recovery*
- **Disaster Recovery** – *Ability to backup and restore from the cloud storage tier efficiently*
- **Accessibility** – *Dynamic cloud storage for inactive files*
- **Centralized management** – *Simplify IT administration*

Cloud Storage Tiering Appliance Key Features
Auto-tiering of data from local disks to the cloud, based on frequency of access
Automatic encryption and decryption of data to and from the cloud
Compression of data sent to the cloud prior to transmission to the cloud
Compliance with HIPPA and PCI security standards
Local snapshots and/or clones
Cloud snapshots and/or clones
Seamless retrieval of data from the cloud
Hardware redundancy between the data centers and/or the cloud
Zero downtime during hardware and software upgrades
Real time monitoring and alerting for proactive management
System maintenance up to 60 months
Use of WAN optimization technology
10Gb internet connectivity – (<i>Optional</i>)

PROJECT DELIVERABLES

This SOW provides for the following deliverables for each data center:

Hardware:

1. Cloud Storage Tiering Appliance in JGB data center
2. Cloud Storage Tiering Appliance in CTF data center

Planning:

1. Detailed Technical Requirements (Bi-weekly)
2. Updated Technical Architecture (Bi-weekly)
3. Updated Data Architecture (Bi-weekly)
4. Documentation for implementation (Bi-weekly)
5. Overall Project Plan updates (Weekly)

Design:

1. Topology drawings
2. Map the solution as per the approved proposal

Services:

JGB

1. Install and configure the hardware
2. Integrate the proposed solution within the current environment.
3. Carve up storage to be presented as iSCSI targets

4. Configure cloud storage tiering capabilities
5. Backup entire configuration

CTF

1. Install and configure the hardware
2. Integrate the proposed solution within the current environment.
3. Carve up storage to be presented as iSCSI targets
4. Configure cloud storage tiering capabilities
5. Backup entire configuration

Testing and Validation:

- Verify the functionality of the cloud storage tiering appliance disaster recovery capabilities
- Verify the connectivity of the cloud storage tiering appliance in JGB and CTF data centers
- Test and validate replication operations
- Validate business continuity and DR of the newly installed infrastructure

Project Closeout:

1. Submit documentation of implementation
2. Provide interoperability guide
3. Provide detailed test plan
4. Provide administration and support tools
5. Provide license management tools
6. Provide all configuration and integration documents
7. Submit topology drawings
8. Obtain technical team acknowledgement that all tasks were completed
9. Provide administrative training manuals

PROJECT GUIDELINES

WMATA Responsibilities shall include the following:

To ensure the success of this engagement, WMATA will assign resources to fulfill the following responsibilities:

- Assign an individual to act as the point of contact (POC) between the vendor and the WMATA for the duration of this engagement.
- Obtain and provide applicable information, data, decisions, and approvals, as required by the vendor, to perform the services, within seven (7) business days of vendor request.
- Assist in the development of installation and project plans as appropriate.
- Provide access to and information for the systems required to fulfill this engagement.
- Where applicable, ensure all necessary hardware is onsite and satisfy all environmental requirements prior to vendor's arrival.

Vendor responsibilities shall include the following:

Experienced technical personnel or authorized agents work with WMATA to deliver the engagement.

This engagement includes the following locations:

Jackson Graham Building

600 Fifth Street, NW
Washington, DC 20001

Carmen Turner Facility
3500 Pennsy Drive
Hyattsville, MD 20850

The tasks for the consultant will encompass, but not be limited ad hoc planning, design, installation and implementation activities to support the project deliverables.

Project Staffing:

The vendor shall deploy a project team made up of the following technical skill sets:

Solutions Provider Architect(s)

The Vendor shall provide at least one Architect to WMATA (two is preferred). The Architect must possess technical experience deploying the proposed solution and at least two years of experience in the following areas: TSM, RMAN and SQL backups and VMware. Responsibilities of the Architect include:

- Certifying site readiness.
- Verifying compatibility and supported hardware/software.
- Attending status meetings, as required.
- Implementation and validation of the technical solution.

The tasks for the consultant will encompass, but not be limited ad hoc planning, design, installation and implementation activities to support the project deliverables.

The RFP responses must address all information specified in this solicitation. All requirements of the RFP must be answered completely. WMATA reserves the right to verify any information contained in the response to this RFP or to request additional information after the RFP response has been received.

Marketing brochures included as part of the main body of the bid response shall not be considered. Such material must be submitted only as attachments and must not be used as a substitute for written responses. In case of any conflict between the content in the attachments and vendors' answers in the body of the proposal, the latter will prevail.

Offeror must provide the following as part of their response to the RFP:

- a. Technical solution
 - Address how your solution meets specifics objectives of the RFP requirements. Offeror response must address each of the stated objectives in the "Scope and Project Deliverables" sections.
- b. Offeror information and Past performance related to the scope of this RFP.
 - Provide core competency of your business, the company's official name and address. An indication of what type of entity it is (for example, corporation or partnership).
 - Provide total number of years the offeror has been in business and, if applicable, the number of years under its present business name.

- Provide a statement giving a brief history of your company, how it is organized, and how its available products and resources will be used to meet WMATA's requirements.
- Provide at least 3 separate customers' references which WMATA may call
- Provide the type of support contract providing similar servers as required in the RFP, duration of the contact, date of award of the contract
- The name, address and telephone number of the person to receive correspondence, and who is authorized to make decisions or represent the vendor. Please state his or her capacity within the company.
- A description of the offeror's operation; facilities, business and objectives, and the number of employees.

Appendix A: Products List

SAN Fabric

Vendor	Product Name	Firmware	Other
Brocade	Backbone	7.0.1	Backbone
Brocade	6510 Switch	7.0.1	Edge
Brocade	5000 Switch	6.4.2b	Edge
Brocade	Blade Server SAN I/O Module - (M5424)	7.0.1	Dell Blade Center
Brocade	Blade Server SAN I/O Module - (5470)	6.4.2.b	IBM Blade Center
Brocade	Blade Server SAN I/O Module - (4020)	6.2.2.d	IBM Blade Center

Transceivers

Vendor	Description	Part Number
Smart Optics	CWDM (4Gbps)	SO-SFP-4GFC-L50D
Brocade	SW SFP (8Gbps)	57-1000012-01
Brocade	SW SPF (4Gbps)	FTLF8524P2BNV

Storage Systems

Vendor	Product Name	Code Level
EMC	VMAX	5876.163.105
EMC	VNX	05.31.000.5015
EMC	RecoverPoint Appliance	6.3 sp1

Backup Systems

Vendor	Product Name	Code Level / Firmware / Software / OS version
Quantum	Scalar i6000	5.3.6 build 11
Septon	S2100-ES VTL	7
IBM	TSM backup software	6.3.4.2
IBM	IBM p520 series server	AIX v6.1

Network Systems

Vendor	Product Name	Product Type	NX-OS / IOS version	Data Rate (Gbps)
Cisco	Nexus (JGB)	7018	6.1(4)	10
Cisco	Nexus (JGB)	7018	6.1(4)	10
Cisco	Nexus (CTF)	7018	6.1(4)	10
Cisco	Nexus (CTF)	7018	6.1(4)	10

Appendix B: Current WMATA Backup Solution

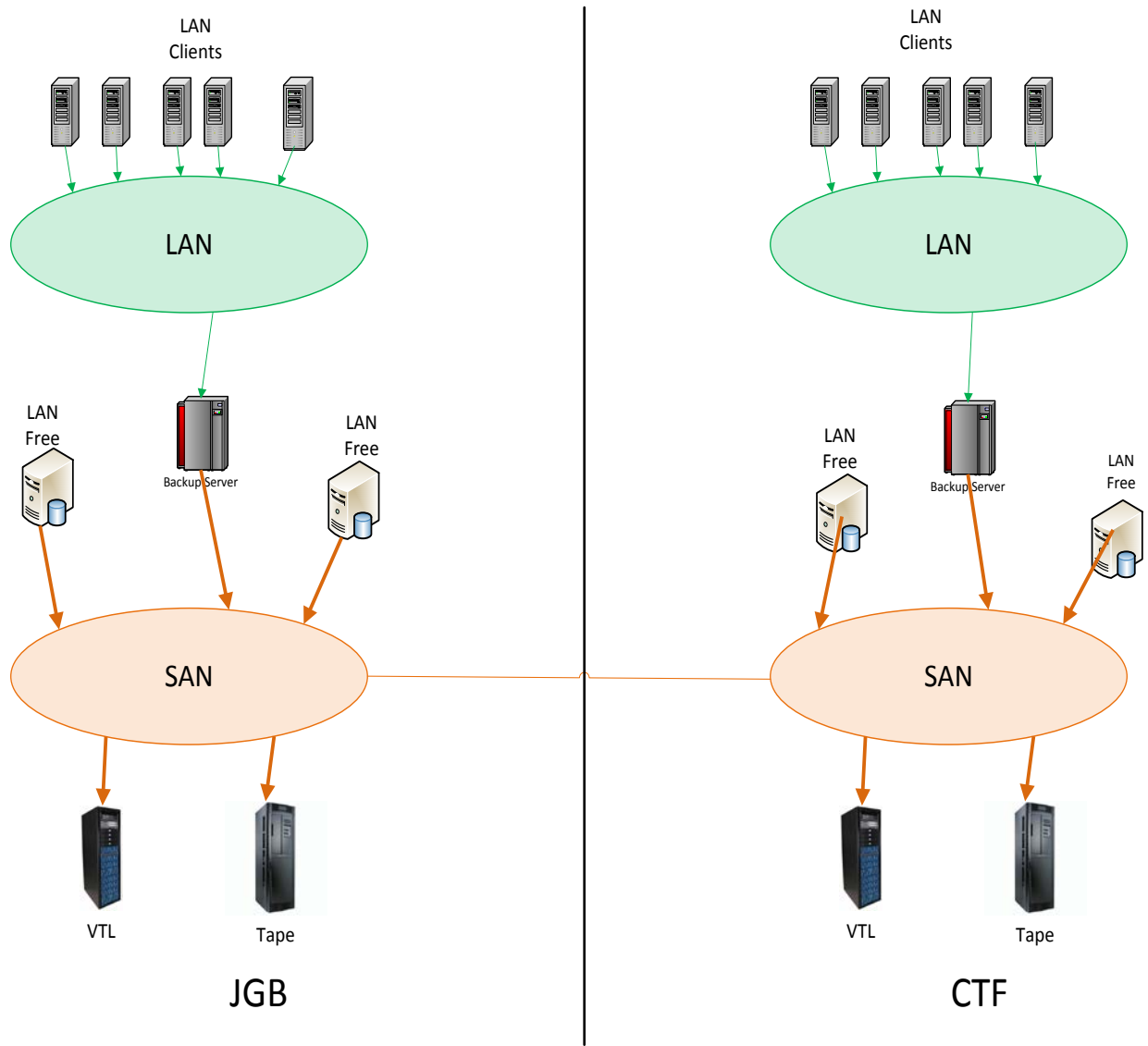

Appendix C: Current WMATA Disaster Recovery Diagram

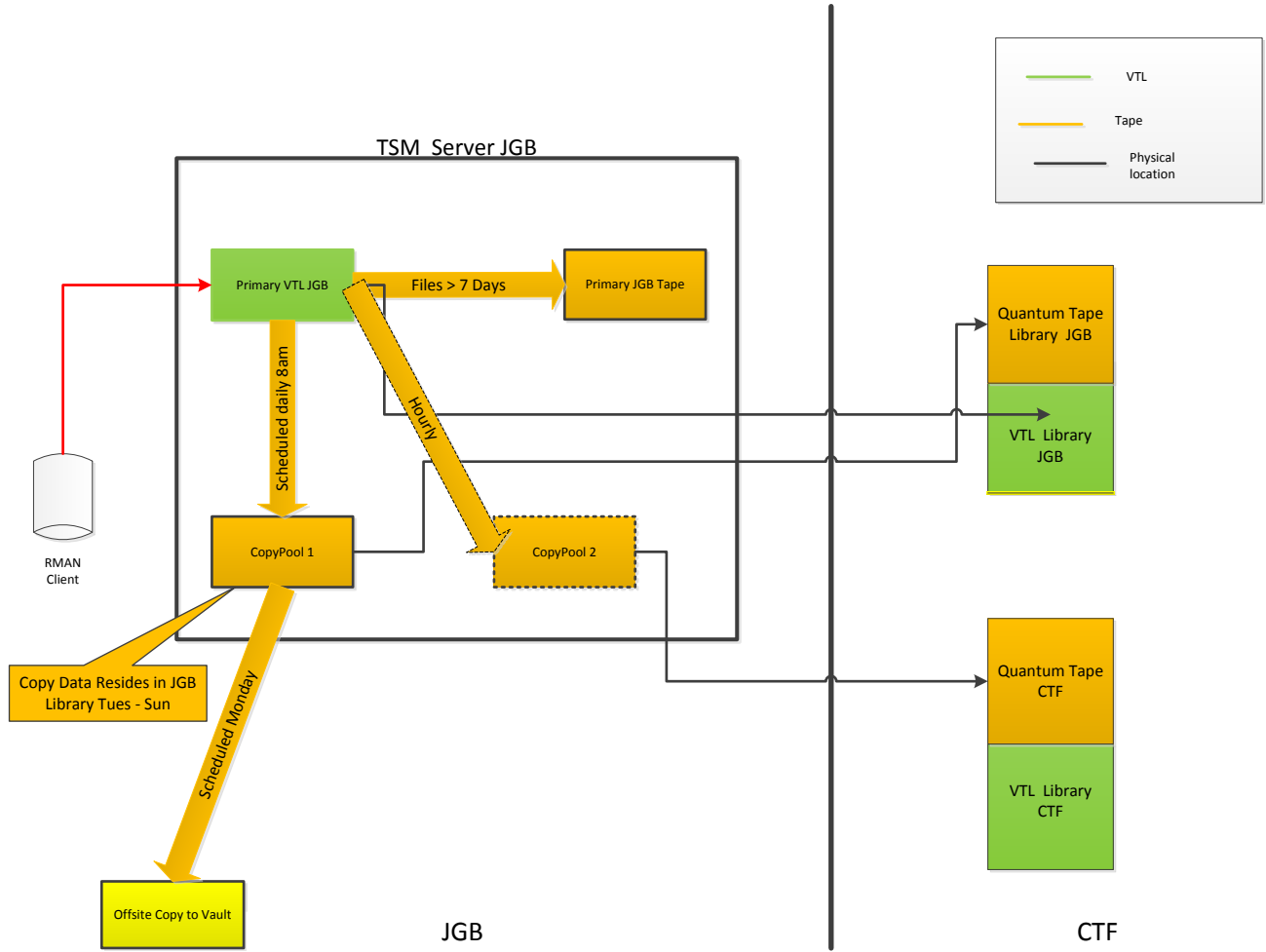

Appendix D: Current WMATA SAN Infrastructure

WMATA SAN Architecture

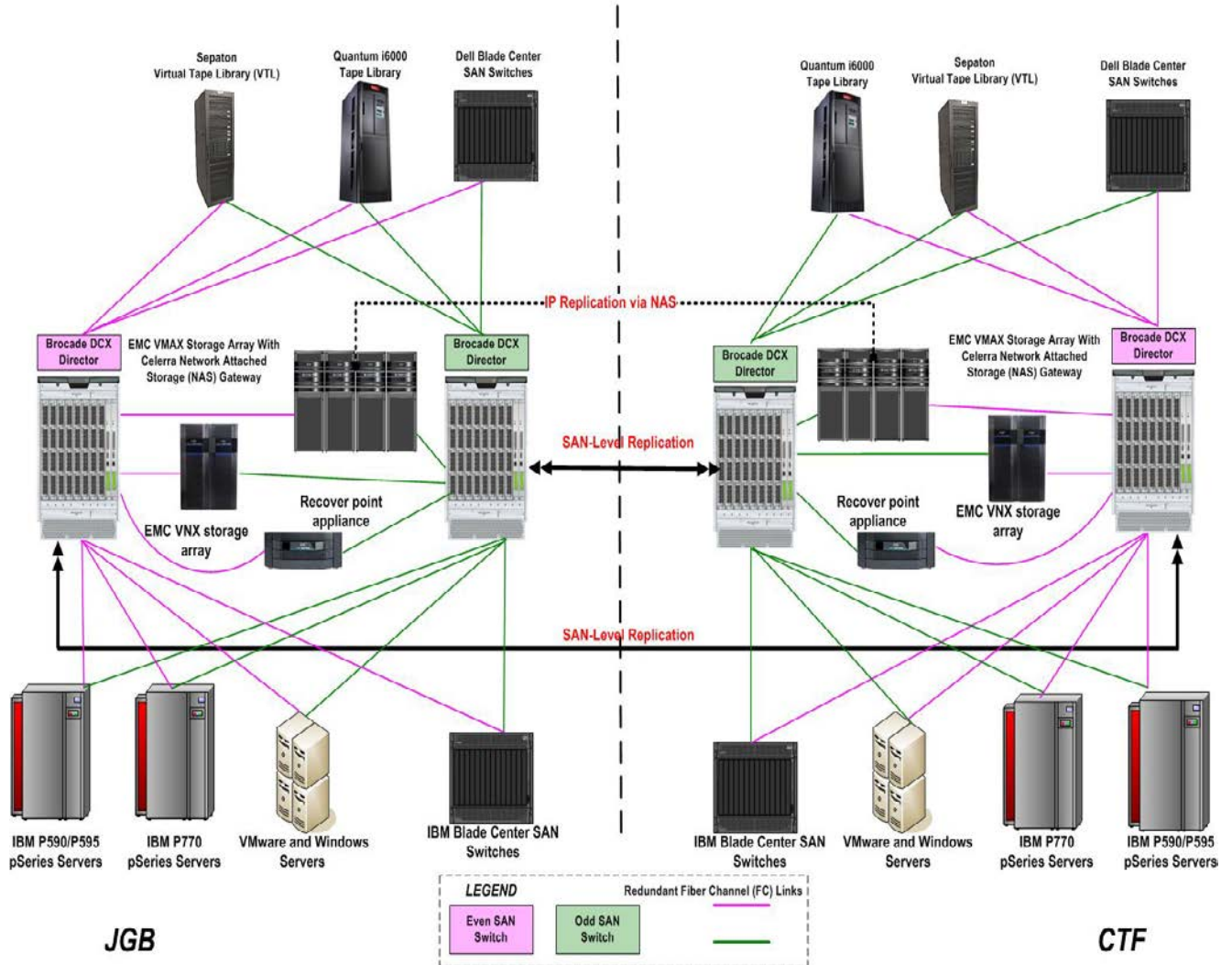

Appendix E: LAN/WAN Data Center Infrastructure

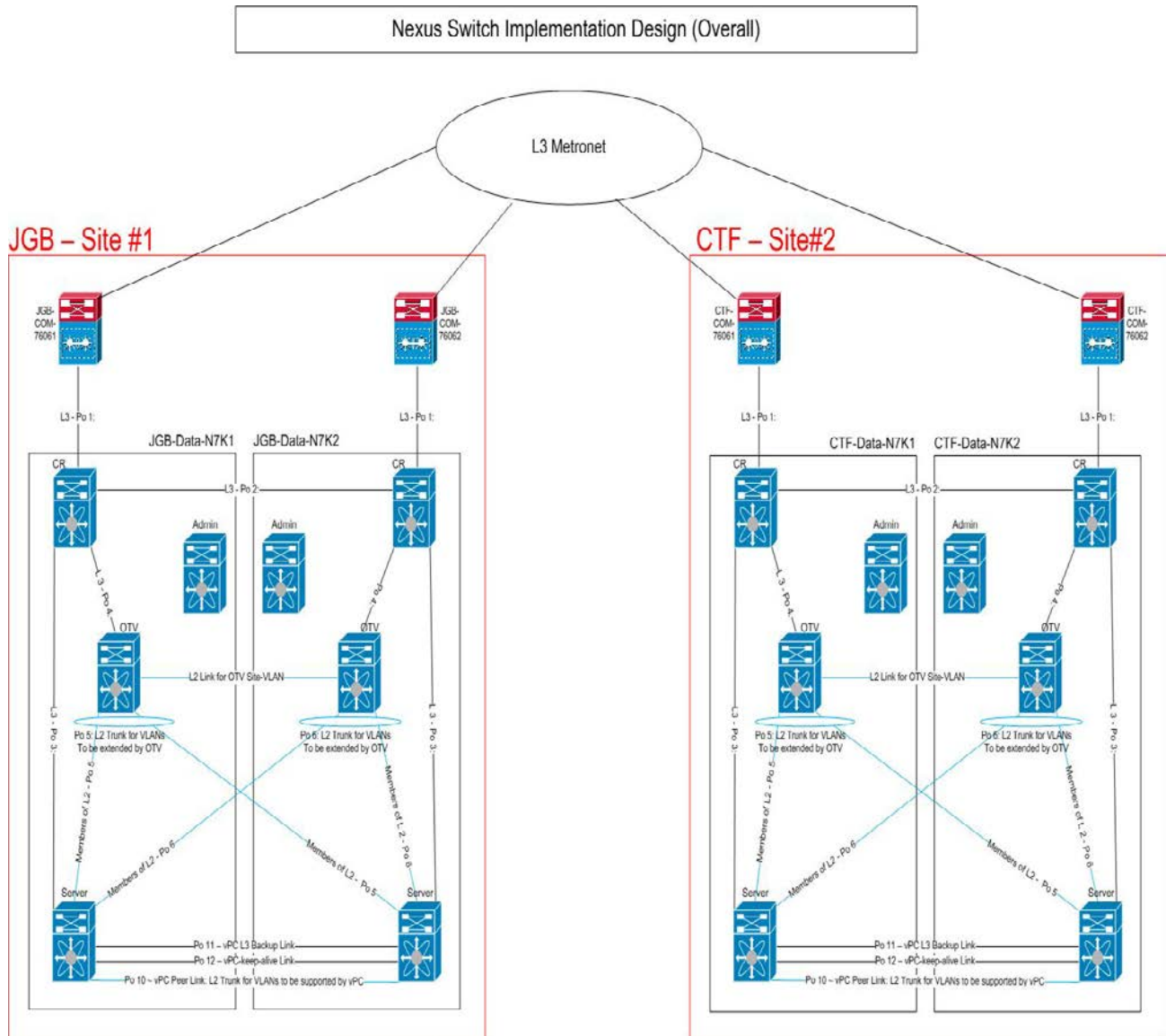

APPENDIX F

DISADVANTAGED BUSINESS ENTERPRISE (DBE)

1. DISADVANTAGED BUSINESS ENTERPRISE (DBE) REQUIREMENT:

- A. The DBE requirements of the Authority's DBE Program Plan apply to this contract. Accordingly, the Contractor shall carry out the requirements of the Authority's DBE Program Plan and this Appendix in the award and administration of this U.S. Department of Transportation (US DOT) assisted contract.

2. POLICY:

- A. It is the policy of the Authority (WMATA), the Federal Transit Administration (FTA) and the US DOT that Disadvantaged Business Enterprises (DBEs) shall compete fairly to receive and participate in performing federally assisted contracts, including contracts and subcontracts at any tier. It is further the policy of the Authority, the FTA and the US DOT that its prime contractors establish procedures to ensure the timely payment of amounts due pursuant to the terms of their subcontracts. The Contractor hereby agrees to carry out this policy in the award and administration of subcontracts to the fullest extent possible consistent with efficient Contract performance.

3. CONTRACT GOAL:

- A. If the proposer is not a DBE, the proposer agrees that the DBE goal for this Contract shall be met by subcontractors or by joint ventures with DBEs. The goal set forth for this Contract is 25% of the final Contract price, including amendment and modification. The amount of DBE participation will be determined by the dollar value of the work performed and/or supplies furnished by DBE firms as compared to the total value of all work performed and/or supplies furnished under this Contract. The Contractor shall have met this goal if the Contractor's DBE participation meets or exceeds this goal.
- B. In cases where work is added to the Contract by modification such that additional DBE participation is necessary to meet this goal, the Contractor shall increase the participation of one or more firms listed on the "Schedule of DBE Participation" or submit additional DBE certified firms to meet the goal. In cases where work is deleted from the Contract, the goal shall be applicable to the new Contract amount. The Contractor shall be permitted to meet the goal by revising its DBE participation, provided, however, that the revision shall not result in DBE participation that is less than the original goal.

4. DEFINITIONS:

- A. **Appendix B.** The Notice of Requirements for Disadvantaged Business Enterprise, which when attached to a solicitation, implements the DBE requirements of the Authority's DBE Program Plan in the award and administration of federally funded Authority contracts.
- B. **Certified DBE.** means a for-profit small business concern (a) that is at least 51 percent owned by one or more individuals who are both socially and economically disadvantaged or, in the case of a corporation, in which 51 percent of the stock is owned by one or more such individuals; (b) whose management and daily business operations are controlled by one or more of the socially and economically disadvantaged individuals who own it; and (c) whose eligibility is evidenced by a current WMATA Certification letter, a D.C. Department of Transportation Certification letter, or a certification letter issued by the Metropolitan Washington Unified Certification Program (MWUCP).
- C. **Contractor.** One who participates, through a contract or subcontract (at any tier), in a US DOT assisted highway, transit or airport program.
- D. **DC DOT.** The District of Columbia Department of Transportation.
- F. **Good Faith Efforts.** Efforts to achieve a DBE goal or other requirements of the Authority's DBE Program Plan which by their scope, intensity, and appropriateness to the objective, can reasonably be expected to fulfill the goal program requirement.
- G. **Joint Venture.** An association of a DBE firm and one or more other firms to carry out a single, for-profit business enterprise, for which the parties combine their property, capital, efforts, skills and knowledge, and in which the DBE is responsible for a distinct, clearly defined portion of the work of the contract and shares in the capital contribution, control, management, risks, and profits of the joint venture commensurate with its ownership interest.
- H. **Metropolitan Washington Unified Certification Program (MWUCP).** A unified certification program mandated by 49 CFR §26.81 between two federal transit recipients (WMATA and the D.C. Department of Transportation). The agreement became effective January 2005.
- I. **Pre-certification.** A requirement under 49 CFR §26.81(c) that all certifications by the MWUCP be made final before the due date for offers on a contract on which a firm seeks to participate as a DBE.
- J. **Race-conscious.** A measure or program that is focused specifically on assisting only DBEs, including women-owned DBEs.
- K. **Race-neutral.** A measure or program that is, or can be, used to assist all small businesses. For the purposes of the DBE program, race-neutral includes gender-neutrality.
- L. **Small Business Concern.** With respect to firms seeking to participate as DBE's in US DOT assisted contracts, a small business concern as defined pursuant to Section 3 of the Small Business Act and Small Business Administration implementing regulations (13 CFR Part 121)

that also does not exceed the cap on average annual gross receipts specified in 49 CFR Part 26.65(b).

- M. **Socially and Economically Disadvantaged Individual.** Any individual who is a citizen (or other lawfully admitted permanent resident) of the United States and who the Authority finds to be a socially and economically disadvantaged individual on a case-by-case basis, and any individual in the following groups, members of which are rebuttably presumed to be socially and economically disadvantaged.
- (1) Black Americans, which includes persons having origins in any of the Black racial groups of Africa;
 - (2) Hispanic Americans, which includes persons of Mexican, Puerto Rican, Cuban, Dominican, Central or South American, or other Spanish or Portuguese culture or origin, regardless of race;
 - (3) Native Americans, which includes persons who are American Indians, Eskimos, Aleuts, or Native Hawaiians;
 - (4) Asian-Pacific Americans, which includes persons whose origins are from Japan, China, Taiwan, Korea, Burma (Myanmar), Vietnam, Laos, Cambodia (Kampuchea), Thailand, Malaysia, Indonesia, the Philippines, Brunei, Samoa, Guam, the U.S. Trust Territories of the Pacific Islands (Republic of Palau), the Commonwealth of the North Marianas Islands, Macao, Fiji, Tonga, Kiribati, Juvalu, Nauru, Federated States of Micronesia, or Hong Kong;
 - (5) Subcontinent Asian Americans, which includes persons whose origins are from India, Pakistan, Bangladesh, Bhutan, the Maldives Islands, Nepal or Sri Lanka;
 - (6) Women; and
 - (7) Any additional groups whose members are designated as socially and economically disadvantaged by the SBA, at such time as the SBA designation becomes effective.
- N. **US DOT Assisted Contract.** Any contract between the Authority and a contractor (at any tier) funded in whole or in part with US DOT financial assistance, including letters of credit or loan guarantees.
- O. **Unified Certification Program (UCP).** The program mandated by 49 CFR Part 26.81(a), which requires all U. S. DOT recipients of federal financial assistance to participate in a statewide certification program by March 2002.
- P. **WMATA.** Washington Metropolitan Area Transit Authority, the transit system (rail and bus)

5. HOW DBE PARTICIPATION IS COUNTED TOWARDS THE CONTRACT GOAL:

DBE participation shall be counted towards meeting the DBE goal in accordance with the following:

- A. When a DBE participates in a contract, only the value of the work actually performed by the DBE is counted towards the DBE goal.
- (1) This amount includes the entire amount of that portion of a construction contract that is performed by the DBE's own forces. This amount includes the cost of supplies and materials obtained by the DBE for the work of the contract, including supplies purchased or equipment leased by the DBE (except supplies and equipment the DBE subcontractor purchases or leases from the prime contractor or its affiliate).
 - (2) This amount includes the entire amount of fees or commissions charged by a DBE firm for providing a bona fide service, such as professional, technical, consultant, or managerial services, or for providing bonds or insurance specifically required for the performance of the contract, towards the DBE goal, provided the fee is reasonable and not excessive as compared with fees customarily allowed for similar services.
 - (3) When a DBE subcontracts part of its work under the contract to another firm, the value of the subcontract work may be counted towards the DBE goal only if the DBE's subcontractor is itself a DBE. Work that a DBE subcontracts to a non-DBE firm does not count towards the DBE goal.
- B. When a DBE performs as a participant in a joint venture, the portion of the total dollar value of the contract equal to the distinct, clearly defined portion of the work of the contract that a DBE performs with its own forces towards the DBE goal may be counted.
- C. Expenditures to a DBE contractor towards the DBE goal may be counted only if the DBE is performing a commercially useful function on that contract.
- (1) A DBE performs a commercially useful function when it is responsible for execution of the work of the contract and is carrying out its responsibilities by actually performing, managing, and supervising the work involved. To perform a commercially useful function, the DBE must also be responsible, with respect to materials and supplies used on the contract, for negotiating price, determining quality and quantity, ordering the material, and installing (where applicable) and paying for the material itself. To determine whether a DBE is performing a commercially useful function, the Authority will consider the amount of work subcontracted, industry practices, whether the amount the firm is to be paid under the contract is commensurate with the work it is actually performing and the

DBE credit claimed for its performance of the work, and other relevant factors.

- (2) A DBE does not perform a commercially useful function if its role is limited to that of an extra participant in a transaction, contract, or project through which funds are passed in order to obtain the appearance of DBE participation.
- (3) If a DBE does not perform or exercise responsibility for at least 30 percent of the total cost of its contract with its own work force, or if the DBE subcontracts a greater portion of the work of a contract than would be expected on the basis of normal industry practice for the type of work, the Authority will presume that the DBE is not performing a commercially useful function.

D. The following factors will be used by the Authority in determining whether a DBE trucking company is performing a commercial useful function:

- (1) The DBE must be responsible for the management and supervision of the entire trucking operation for which it is responsible for on a particular contract, and there cannot be a contrived arrangement for the purpose of meeting the DBE goal.
- (2) The DBE must itself own and operate at least one fully licensed, insured and operational truck used on the contract.
 - (3) The DBE receives credit for the total value of the transportation services it provides on the contract using trucks it owns, insures, and operates using drivers, it employs.
- (3) The DBE may lease trucks from another DBE firm, including an owner-operator who is certified as a DBE. The DBE who leases trucks from another DBE receives credit for the total value of the transportation services the lessee DBE provides on the contract.
- (5) The DBE may also lease trucks from a non-DBE firm, including an owner-operator. The DBE who leases trucks from a non-DBE is entitled to credit only for the fee or commission it receives as a result of the lease arrangement. The DBE does not receive credit for the total value of the transportation services provided by the lessee, since these services are not provided by a DBE.
- (6) The lease must indicate that the DBE has exclusive use of and control over the truck. This does not preclude the leased truck from working for others during the terms of the lease with the consent of the DBE, so long as the lease gives the DBE absolute priority for use of the leased truck. Leased trucks must display the name and identification number of the

- E. The following factors will be used to count expenditures with DBEs for materials or supplies towards the DBE goal:
- (1) If the materials or supplies are obtained from a DBE manufacturer, 100 percent of the cost of the materials or supplies will be counted towards the DBE goal. A manufacturer is a firm that operates or maintains a factory or establishment that produces, on the premises, the materials, supplies, articles, or equipment required under the contract and of the general character described by the contract.
 - (2) If the materials or supplies are purchased from a DBE regular dealer, 60 percent of the cost of the materials or supplies will be counted towards the DBE goal. A regular dealer is a firm that owns, operates or maintains a store, warehouse, or other establishment in which the materials, supplies, articles or equipment of the general character described and required under the contract are bought, kept in stock, and regularly sold or leased to the public in the usual course of business. To be a regular dealer, the firm must be an established, regular business that engages, as its principal business and under its own name, in the purchase and sale or lease of the products in question. A person may be a regular dealer in such bulk items as petroleum products, steel, cement, gravel, stone or asphalt without owning, operating, or maintaining a place of business as provided in this paragraph if this person both owns and operates distribution equipment for the products. Any supplementing of regular dealers' own distribution equipment shall be by long-term lease agreement and not on an ad hoc or contract-by-contract basis. Packagers, brokers, manufacturers' representatives, or other persons who arrange or expedite transactions are not regular dealers within the meaning of this paragraph.
 - (3) With respect to materials or supplies purchased from a DBE which is neither a manufacturer nor a regular dealer, the entire amount of fees or commissions charged for assistance in the procurement of the materials and supplies, or fees or transportation charges for the delivery of materials and supplies required on a job site, may be counted towards the DBE goal, provided the fees are reasonable and are not excessive as compared with fees customarily allowed for similar services. The cost of the materials and supplies themselves may not be counted towards the DBE goal.
- F. All DBE firms must be pre-certified. Participation by a firm that is not currently certified as a DBE by the Authority at the time of the due date for offers on a contract, does not count towards the DBE goal. All DBE firms must be in compliance with 49 CFR, Part 26.
- G. The dollar value of work performed under the contract by a firm who has been decertified as a

DBE by the MWUCP does not count towards the DBE goal.

- H. The participation of a DBE subcontractor does not count towards the Contractor's DBE goal until the amount being counted towards the goal has been paid to the DBE.

6. PROPOSAL REQUIREMENTS (WITH THE PROPOSAL):

The proposer shall submit the following with its proposal. Any proposer who fails to complete and return this information with its proposal shall be deemed to be not responsive and may be ineligible for contract award. Proposers that fail to meet the DBE goal above and fail to demonstrate "good faith efforts" to justify waiver of the DBE goal (see paragraph 6.C. below) shall be deemed to be not responsible and will be ineligible for Contract award.

- A. Completed "Schedule of DBE Participation" (Attachment B-1) sufficient to meet the above goal. If the proposer is a DBE firm and intends to satisfy the appropriate DBE requirement with its own firm, it must indicate in the Schedule the area of work and percentage it will perform to satisfy the goal. All proposers must attach current WMATA, DC DOT or MWUCP certification letters for each DBE listed on the Schedule.
- B. Executed "Letters of Intent to Perform as a Subcontractor/Joint Venture" (Attachment B-2). If the proposer is not a DBE or intends to satisfy the requirements through other DBE firms, then it must attach these letters from each certified DBE listed on the Schedule.
- C. Justification for grant of relief (Appendix B waiver of DBE goal). If in the submittal of its proposal, the proposer fails to meet the DBE goal above, the proposer has the burden of furnishing sufficient documentation with its proposal of its "good faith efforts" to justify a grant of relief (waiver) from the goal or portion of the goal. Such justification shall be in the form of a detailed report. The following is a list of actions which shall be considered as part of the proposer's good faith efforts to obtain DBE participation. This list is neither a mandatory checklist nor is it intended to be exclusive or exhaustive. Other factors or types of efforts may be relevant in appropriate cases:
- (1) Soliciting through all reasonable and available means (e.g. attendance at pre-proposal meetings, advertising and/or written notices) the interest of all certified DBEs who have the capability to perform the work of the contract. The proposer must solicit this interest within sufficient time to allow the DBEs to respond to the solicitation. The proposer must determine with certainty if the DBEs are interested by taking appropriate steps to follow up initial solicitations.
 - (2) Selecting portions of the work to be performed by DBEs in order to increase the likelihood that the DBE goal will be achieved. This includes, where appropriate, breaking out contract work items into economically feasible units to facilitate DBE participation, even when the prime contractor might otherwise prefer to perform these work items with its own forces.

- (3) Providing interested DBEs with adequate information about the plans, specifications, and requirements of the contract in a timely manner to assist them in responding to a solicitation.
- (4)
 - (a) Negotiating in good faith with interested DBEs. It is the proposer's responsibility to make a portion of the work available to DBE subcontractors and suppliers and to select those portions of the work or material needs consistent with the available DBE subcontractors and suppliers, so as to facilitate DBE participation. Evidence of such negotiation includes the names, addresses, and telephone numbers of DBEs that were considered; a description of the information provided regarding the plans and specifications for the work selected for subcontracting; and evidence as to why additional agreements could not be reached for DBEs to perform the work. "DBE Unavailability Certifications" (Attachment B-3) shall be completed as appropriate.
 - (b) A proposer using good business judgment would consider a number of factors in negotiating with subcontractors, including DBE subcontractors, and would take a firm's price and capabilities as well as the contract goal into consideration. However, the fact that there may be some additional costs involved in finding and using DBEs is not in itself sufficient reason for a proposer's failure to meet the contract DBE goal, as long as such costs are reasonable. Also, the ability or desire of a prime contractor to perform the work of a contract with its own organization does not relieve the proposer of the responsibility to make good faith efforts. Prime contractors are not, however, required to accept higher quotes from DBEs if the price difference is excessive or unreasonable.
- (5) Not rejecting DBEs as being unqualified without sound reasons based on a thorough investigation of their capabilities. The contractor's standing within its industry, membership in specific groups, organizations, or associations and political or social affiliations (for example union vs. non-union employee status) are not legitimate causes for the rejection or non-solicitation of proposals in the contractor's efforts to meet the project goal.
- (6) Making efforts to assist interested DBEs in obtaining bonding, lines of credit, or insurance as required by the recipient or contractor.
- (7) Making efforts to assist interested DBEs in obtaining necessary equipment, supplies, materials, or related assistance or services.
- (8) Effectively using the services of available minority/women community organizations; minority/women contractors' groups; local, state, and Federal minority/women business assistance offices; and other

organizations as allowed on a case-by-case basis to provide assistance in the recruitment and placement of DBEs.

7. PROPOSAL REQUIREMENTS (APPARENT SUCCESSFUL PROPOSER):

The proposer shall submit the following items within ten (10) calendar days after notification that they are the apparent successful proposer:

- A. A copy of a current WMATA, D.C. DOT or MWUCP certification letter(s) shall be attached to the DBE Schedule of Participation to evidence DBE pre-certification.
- B. DBE Manufacturer's Affidavit, if applicable, must be submitted in order to receive 100 percent of the allowable credit for expenditures to DBE manufacturers/suppliers (Attachment B-4). By submission of this Affidavit, the proposer certifies this it is satisfied that the manufacturer meets the requirements of 49 CFR Part 26.
- C. Schedule B Information for Determining Joint Venture Eligibility, if applicable (Attachment B-5, pgs. 1, 2, 3, 4). Submittal shall be signed by all parties, dated and notarized.
- D. Copy of Joint Venture Agreement, if applicable. Submittal shall be signed by all parties, dated and notarized.
- E. Certification letter of the DBE regular dealer/supplier, if applicable. If the proposer wants to receive the maximum allowable credit of its expenditures for material(s) or supplies required under this Contract, from DBE regular dealers/suppliers, the DBE must submit a signed and notarized statement on their letterhead, that they are a regular dealer of the material(s) or supplies. By submission of this statement, the proposer certifies that it is satisfied that the subcontractor is a regular dealer/supplier that meets the requirements of 49 CFR Part 26.
- F. For Design-Build contracts, if a DBE goal is specified in Section 00872, DBE GOAL REQUIREMENTS, the proposer shall submit with its initial Price Proposal a list of DBE-certified firms that it intends to enter into subcontract agreements with for this Contract. If no goal is specified in Section 00872 of the solicitation and the proposer still intends to utilize DBEs in the performance of this Contract, the proposer shall submit with its initial Price Proposal a list of those DBE-certified firms. The documentation requirements of Section 00453 of the solicitation shall be completed and submitted at the time set forth for the submittal of Best and Final Offer (BAFO) to the Authority for any Contract in which a DBE goal is applicable or for any Contract in which there was no goal established, but the proposer identified DBE-certified firms that it intends to enter into subcontract agreements with in its initial Price Proposal. Any proposer who fails to complete and return the following information, if applicable, with their BAFO Price Proposal may be deemed to be not responsible and may be

ineligible for contract award. Proposers that fail to meet the DBE goal, if any, specified in Section 00872 and fail to demonstrate a good faith effort and to justify waiver of the DBE goal may be deemed to be not responsible and may be ineligible for contract award.

8. CONTRACT ADMINISTRATION REQUIREMENTS:

The following requirements apply after contract award:

- A. The Contractor shall include the following provision in the General Provisions of each subcontract it awards in support of the DBE goal:

“The contractor shall not discriminate on the basis of race, color, national origin or sex in the performance of this contract. The contractor shall carry out applicable requirements of 49 CFR Part 26 in the award and administration of US DOT assisted contracts. Failure by the contractor to carry out these requirements is a material breach of this contract, which may result in termination of this contract or such other remedy as the Buyer deems appropriate.”

- B. (1) The Contractor shall monitor the performance of, collect and report data on DBE participation to the WMATA’s DBE office on the attached “Prompt Payment Report-Prime Contractor’s Report” (Attachment B-6) which shall be submitted monthly with each payment request. Failure to submit these reports may result in suspension of contract payments. The Contractor shall certify with each payment request that payment has been or will be made to all subcontractors due payment, within ten (10) days after receipt of payment from the Authority for work by that subcontractor. The Contractor shall inform the COR or COTR, with their payment request, of any situation in which scheduled subcontractor payments have not been made and the reason therefore.

(2) The Contractor shall require each sub-contractor to complete and forward to the DBE Liaison Officer on a monthly basis a “Prompt Payment Report-Subcontractor’s Report” (Attachment B-7). The sub-contractor shall certify that payment has been received.

- C. The Contractor shall have a continuing obligation to maintain a schedule for participation by DBE contractor(s) to meet its goal set forth above in this Appendix. The Contractor shall not have work performed nor the materials or supplies furnished by any individual or firm other than those named in the “Schedule of DBE Participation.” If at any time, the Contractor believes or has reason to believe that it needs to obtain a substitute for a DBE contractor named in the “Schedule of DBE Participation”, the Contractor shall, within ten (10) days, notify the contracting officer and the DBE office of that fact in writing. Situations which may warrant substitution for a DBE firm include, but are not limited to the following:

- (1) Evidence of change in ownership or circumstances regarding the firm’s

status as a DBE.

- (2) Death or physical disability, if the named subcontractor or DBE partner of the joint venture is an individual.
- (3) Dissolution, if a corporation or partnership.
- (4) Bankruptcy of the subcontractor, subject to applicable bankruptcy law, and only instances where the bankruptcy affects the Contractor's ability to perform.
- (5) Inability to furnish a reasonable performance or payment bond, if required.
- (6) Inability to obtain, or loss of, a license necessary for the performance of the particular category of work.
- (7) Failure or inability to comply with a requirement of law applicable to contractors and subcontractors on a construction, alteration or repair project.
- (8) Failure or refusal to execute the subcontract in accordance with the terms of an offer submitted to the Contractor prior to the Contractor's submission of its proposal, but only where the contracting officer or other delegated authority's representative can ascertain with reasonable certainty the terms of such offer. In the absence of any other factors, such a failure or refusal will be considered an unusual situation only if the proposer obtained, prior to proposing, an enforcement commitment from the subcontractor involved.
- (9) Failure to comply with the terms and conditions of this Contract or those of its subcontract or joint venture agreement.

Within 30 days thereafter, the Contractor shall, if necessary to achieve the Appendix B goal, make every reasonable effort to subcontract the same or other work equivalent in value to other certified DBE firms. The Contractor must have the prior written approval of the contracting officer and the DBE office before substitution for a DBE subcontractor, regardless of the reason for substitution. Failure to obtain Authority approval could result in the Authority declaring the Contractor ineligible to receive further Authority contracts for three years from the date of the finding.

- D. The contractor shall forward copies of all subcontracts to the DBE office at the time of their execution.
- E. If the contracting officer or other delegated authority's representative determines that the Contractor has failed to comply with this Appendix B, he/she will notify the Contractor of such non-compliance and the action to be taken. The Contractor shall, after receipt of

such notice, take corrective action. If the Contractor fails or refuses to comply promptly, the contracting officer or other delegated authority's representative may issue a "stop work order" stopping all or part of the work until satisfactory corrective action has been taken. No part of the time lost due to any such stop work order shall be made the subject of claim for extension of time or for excess costs or damages by the Contractor. When the Authority proceeds with such formal actions, it has the burden of proving that the Contractor has not met the requirements of this Appendix, but the Contractor's failure to meet its Appendix B goal shall shift to it the requirement to come forward with evidence to show that it has met the good faith requirements of this Appendix. Where the Contractor, after exhausting all its administrative and legal remedies and procedures is found to have failed to exert a "good faith effort" to involve DBE's in the work as herein provided, the Authority may declare the Contractor ineligible to receive further Authority contracts for three years from the date of the finding.

- F. The Contractor agrees to cooperate in any studies or surveys as may be conducted by the Authority which are necessary to determine the extent of the Contractor's compliance with this Appendix.
- G. The Contractor shall keep records and documents for two years following performance of this Contract to indicate compliance with this Appendix. These records and documents, or copies thereof, shall be made available at reasonable times and places for inspection by any authorized representative of the Authority and will be submitted upon request together with any other compliance information which such representative may require.
- H. If the Authority, the FTA or the US DOT has reason to believe that any person or firm has willfully and knowingly provided incorrect information or made false statements regarding the DBE Program, the matter shall be referred to the WMATA's DBE office.
- I. Failure by the Contractor to carry out the requirements of this Appendix is a material breach of this Contract, which may result in the termination of this Contract under the Default provision of this Contract or such other remedy as the Authority deems appropriate.

SUMMARY OF SUBMITTALS

With the Proposal

1. Completed "Schedule of DBE Participation" (Attachment B-1) with current certification letters attached for each listed DBE.
2. Executed "Letters of Intent to Perform as a Subcontractor/Joint Venture" (Attachment B-2).
3. Justification for grant of relief (waiver of DBE goal), if applicable. Include completed "DBE Unavailability Certifications" (Attachment B-3) as appropriate.

Proposal Requirements (Apparent Successful Proposer)

1. All DBEs must submit a copy of their current WMATA or DC DOT certification letters or a certification letter issued by the MWUCP.
2. DBE Manufacturer's Affidavit, if applicable, must be submitted in order to receive 100 percent of the allowable credit for expenditures to DBE manufacturers/suppliers (Attachment B-4).
3. Schedule B Information for Determining Joint Venture Eligibility, if applicable (Attachment B-5, pgs. 1, 2, 3, 4).
4. Copy of Joint Venture Agreement, if applicable.
5. Certification letter of the DBE regular dealer/supplier, if applicable.

After Contract Award

1. "Prompt Payment Report-Prime Contractor's Report" Attachment B-6) – submitted monthly.
"Prompt Payment Report-Subcontractor's Report" (Attachment B-7) - submitted monthly.
3. Request to substitute DBE contractor (see paragraph 8.C.) – submitted as required.
Copies of subcontracts-submitted at the time of their execution.

SUBMIT WITH PROPOSAL
SCHEDULE OF DBE PARTICIPATION

Contract No. _____

Project Name _____

Name of Proposer

The proposer shall complete this Schedule by identifying only those DBE firms, with scope of work and price, who have agreed to perform work on this Contract. The prices for the work/supplies of these firms shall be at prices amounting to at least the DBE percentage goal of the total contract price. The proposer agrees to enter into a formal agreement with the DBE firm(s) listed for the work and at, or greater than, the prices listed in this Schedule subject to award of a Contract with the Authority. If the total amount is less than the DBE percentage goal, a justification for waiver of DBE goal shall be attached to this Schedule.

Name of DBE Subcontractor	Address	Type of Work (Electrical, Paving, Etc.) and Contract Items or Parts Thereof to be Performed and Work Hours Involved	Agreed Price
Subtotal \$ DBE Subcontractors			
Name of DBE Prime Contractor	Address	Type of Work (Electrical, Paving, Etc.) and Contract Items or Parts Thereof to be Performed and Work Hours Involved	Agreed Price
Subtotal \$ DBE Prime Contractor			
TOTAL \$ ALL DBE CONTRACTORS		TOTAL	

 Signature of Contractor Representative

 Title

 Date

M 23.26a (Rev 02/12)

Project Name: _____

**LETTER OF INTENT TO PERFORM AS A SUBCONTRACTOR/JOINT VENTURE
(ALL ITEMS MUST BE COMPLETED)**

TO: _____
(Name of Proposer)

The undersigned intends to perform work in connection with the above projects as (check one):

an individual a corporation
 a partnership a joint venture

Specify in detail particular work items or parts thereof to be performed:

at the following price: \$ _____

Please indicate _____% of the dollar value of the subcontract that will be awarded to non-DBE contractors, if applicable. The undersigned will enter into a formal agreement with you for the above work upon your execution of a contract with the Authority.

Name of DBE Subcontractor/Joint Venture	Phone Number
Address	WMATA Vendor ID #/DBE Cert. #
Signature & Title	Date

 The following is to be completed by the Prime Contractor. A copy of this letter must be returned to the DBE subcontractor to indicate acceptance.

To: _____
(Name of DBE)

You have projected your interest and intent for such work, and the undersigned is projecting completion of such work as follows:

<u>WORK</u>	PROJECTED DBE	PROJECTED DBE
<u>ITEMS</u>	COMMENCEMENT	COMPLETION
	<u>DATE</u>	<u>DATE</u>

(Date)

(Name of Prime Contractor &

Acceptance Signature)

SUBMIT WITH PROPOSAL

DBE UNAVAILABILITY CERTIFICATION

I, _____, _____, of _____
(Name) (Title) (Proposer)

certify that on _____ I contacted the following DBE contractor to obtain a proposal for work
(Date)
items to be performed on Contract Number _____.

<u>DBE Contractor</u>	<u>Work Items Sought</u>	<u>Form of Proposal Sought (i.e., Unit Price, Materials and Labor Only, Etc.)</u>
-----------------------	--------------------------	---

To the best of my knowledge and belief, said DBE contractors were unavailable (exclusive of unavailability due to lack of agreement on price) for work on this project, or unable to prepare a proposal, for the following reason(s):

Signature: _____

Date: _____

_____ was offered an opportunity to propose on the above
(Name of DBE Contractor)
identified work on _____ by _____
(Date) (Source)

The above statement is true and accurate account of why I did not submit a propose on this project.

(Signature of DBE Contractor)

(Title)

M	23.25 (Rev 10/99)
M	

DBE Certification Instructions

Important Notice

If you do not have a current, official letter of certification from WMATA, D.C. DOT or MWUCP, you are not pre-certified and are therefore not eligible to participate as a Disadvantaged Business Enterprise on the proposal.

For those who wish to access the MWUCP certification application, it may be found on the internet at the following address:

https://www.wmata.com/business/disadvantaged_business_enterprise. Go to “Procurement and Contracting”, click on “Disadvantaged Business Enterprise”, then click on “DBE Application for Certification”.

49 CFR Part 26 gives Metropolitan Washington Unified Certification Program (MWUCP) 90 days in which to process a complete DBE application. In order to become certified and participate in the MWUCP, you must comply with the procedures that follow. Certification must be final before the due date for offers on a contract on which a firm seeks to participate as a DBE.

Instructions

49 CFR Part 26.81(d) of the Certification Procedures requires a firm to be certified as a DBE in its “home state”, where it has its principal place of business, in order to become certified outside such “home state”. Therefore, you must attach a copy of a valid DBE Certification letter from your home state Department of Transportation to the MWUCP Application. In addition, submit the pertinent documents for your company listed below. The application should be completed in full and **NOTARIZED**.

General (All firms must submit documents under General)

- Current (unaudited) Financial Statements
- Prior three (3) years Federal Tax Returns
- Resume of Principal(s) and Key Personnel
- Third Party Agreements, such as Rental and Management Agreements
- Licenses to Do Business
- Personal Net Worth (PNW) Statement
- Statement of Disadvantage
- No Change Affidavit or Notice of Change (where applicable)

Corporations

- Articles of Incorporation
- By-Laws
- Stock Ownership Options
- Copy of Stock Certifications of Each Holder
- Copy of Voting Rights
- Record of First Organizational Meeting

Partnerships

- Partnership Agreement

Proprietorships

- IRS Employer ID Number
- WMATA Vendor ID#

Limited Liability Companies

Operating Agreement
Certificate of Formation, Operating Agreement with any amendments
U.S. Corporate or Partnership Income Tax Returns

Change of Status Review

On or before each certification anniversary date, you must submit a No Change Statement attesting that there have been no changes in the firm's circumstances affecting its ability to meet the eligibility requirements of 49 CFR Part 26 or WMATA's DBE Program Plan. Those firms which have undergone changes in circumstances must submit a Notice Regarding Change for review by the Office of Procurement and Materials, DBE Unit. A review of these changes shall be made to determine if the firm is in compliance with the 49 CFR Part 26.

Affidavit Enclosure

NOTE: When completing MWUCP Application, complete all information blocks. Type "N/A" if item does not apply to you or your firm.

DBE MANUFACTURER'S AFFIDAVIT

I hereby declare and affirm that I am _____ (Title)
 and duly authorized representative of _____ (Name of Company),
 a _____ owned and controlled enterprise
 whose address is _____

I further declare and affirm that company employees (persons not on the payroll of and/or performing the same tasks for disadvantaged owned business having any interest in the affiant's business) operate the following company equipment relative to the manufacturing process:

Equipment

Type	Function	Model	Age	Make
------	----------	-------	-----	------

Number of employees involved in the manufacturing process: _____

The undersigned swears that the foregoing statements are true and correct and fully understands that WMATA may rely on these statements in determining whether a WMATA prime contractor purchasing goods from the undersigned's manufacturing concern is entitled to a 100% credit of such purchases towards its DBE goal. The undersigned further understands that any material misrepresentation will be grounds for initiating action under Federal or state laws concerning false statements.

_____ Signature of Affiant	_____ Printed Name
-------------------------------	-----------------------

Date: _____ State: _____ County: _____

On this _____ day of _____, 19_____,
 before me appeared _____
 (Name)

to me personally known, who, being duly sworn, did execute the foregoing Affidavit, and did state that he or she was properly authorized by _____
 (Name of Firm)

to execute the Affidavit and did so as his or her free act and deed.

(Seal) Sworn and subscribed before me _____
 (Notary Public)

Commission Expires: _____

23.29 (10/99) M

Information For Determining Joint Venture Eligibility

Page 1

.....
Name and address of Joint Venture:

Contact Person: _____ Telephone: _____

Have you attached a copy of the Joint Venture agreement? Yes No

NOTE: Affidavit will not be processed without a copy of the Joint Venture agreement.

.....
Name and address of Joint Venture partner: _____

Contact Person: _____ Telephone: _____

Status of firm: DBE. Non-Minority.

Does firm have current WMATA, DC DOT or MWUCP DBE certification? Yes No

.....
Name and address of Joint Venture partner: _____

Contact Person: _____ Telephone: _____

Status of firm: DBE. Non-Minority.

Does firm have current WMATA, DC DOT or MWUCP DBE certification? Yes No

.....
Describe the nature of the Joint Venture business:

Describe the role in the Joint Venture of each partner listed above:

Describe the experience and business qualifications of each partner in the Joint Venture listed above:
.....

Information For Determining Joint Venture Eligibility

Page 2

.....
.
Indicate the percentage of ownership in the Joint Venture for each Joint Venture partner, indicating dollar amounts wherever applicable.

Name of Partner	Percentage of Ownership	Profit and Loss Sharing	Capital Contributions including Equipment	Other Agreements
_____	_____	_____	_____	_____
_____	_____	_____	_____	_____
_____	_____	_____	_____	_____

TOTALS:

.....
.
Identify by name, title, race, sex and company affiliation those individuals responsible for the management control of and participation in this contract:

1. Financial decisions, such as payroll, insurance, surety and/or bonding requirements:

Name: _____ Race: _____

Title: _____ Sex: Male Female

Company affiliation: _____

2. Management decisions, such as estimating, marketing and sales, hiring and firing, purchasing supplies:

Name: _____ Race: _____

Title: _____ Sex: Male Female

Company affiliation: _____

3. Supervision of field operations:

Name: _____ Race: _____

Title: _____ Sex: Male Female

Company affiliation: _____
.....
.

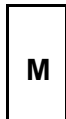

23.06c (Rev 10/99)

Information For Determining Joint Venture Eligibility

.....
The undersigned swear that the foregoing statements are correct and include all material information necessary to identify and explain the terms and operations of our following named Joint Venture:

.....
and the intended participation by each Joint Venturer in the undertaking. Further the undersigned covenant and agree to provide the Authority current, complete and accurate information regarding actual Joint Venture work and the payment thereof and any proposed changes in any of the Joint Venture arrangements and to permit the audit and examination of the books, records and files of the Joint Venture, or those of each Joint Venturer relevant to the Joint Venture, by authorized representatives of the Authority or the Federal funding agency. Any material misrepresentation will be grounds for terminating any contract which may be awarded and for initiating action under Federal and State laws concerning false statements.

It is recognized and acknowledged that the Authority's DBE Program shall have access to the information provided herein above for the purpose of establishing eligibility and authenticity of the minority/woman-owned status of the Joint Venture.

It is understood that trade secrets and information privileged by law, as well as commercial, financial, geological and geophysical data furnished will be protected.

_____ (NAME OF FIRM)	_____ (NAME OF SECOND FIRM)
_____ (SIGNATURE OF AFFIANT)	_____ (SIGNATURE OF AFFIANT)
_____ (PRINT NAME)	_____ (PRINT NAME)
_____ (TITLE)	_____ (TITLE)
_____ (DATE)	_____ (DATE)

.....
...

23.29 (10/99)



Information For Determining Joint Venture Eligibility

Page 4

.....
Date: _____ State: _____ County: _____

On this _____ day of _____, 19____,

before me appeared _____
(Name)

to me personally known, who, being duly sworn, did execute the foregoing Affidavit, and did state that he or she was properly authorized by _____
(Name of Firm)

to execute the Affidavit and did so as his or her free act and deed.

(Seal) Sworn and subscribed before me _____
(Notary Public)

Commission Expires: _____

.....
Date: _____ State: _____ County: _____

On this _____ day of _____, 19____,

before me appeared _____
(Name)

to me personally known, who, being duly sworn, did execute the foregoing Affidavit, and did state that he or she was properly authorized by _____
(Name of Firm)

to execute the Affidavit and did so as his or her free act and deed.

(Seal) Sworn and subscribed before me _____
(Notary Public)

Commission Expires: _____

.....
M 23.06c (Rev 10/99)

Washington Metropolitan Area Transit Authority

DISADVANTAGED BUSINESS ENTERPRISE (DBE)
MONTHLY PROMPT PAYMENT REPORT

PRIME – CONTRACTOR’S REPORT

This report is required to be submitted to the Office of Procurement, DBE Branch 600 5th Street, NW, Suite 3C, Washington, DC 20001, pursuant to the requirements of WMATA’s DBE Program Plan and §26.29 of 49 CFR Part 26.

Contract No.: _____ Reporting Period: _____

Name of Prime Contractor: _____ DBE – Yes or No

Prime Contract Amount: _____ Total Received this Reporting Period: _____ Total Received to Date: _____
DBE Goal 25%

Name of Sub-Contractor	DBE (Y/N)	Description of Work	Date of Contract Awarded	Amount of Sub-Contractor Award	Amount Paid This Reporting Period	Cumulative Paid To Sub-Contractor	% of Physical Work Complete
TOTAL							

I certify the information furnished with respect to DBE subcontractor performance correct to the best of my knowledge and represents a current status of the prime contractor with the DBE subcontractors for the designated period covered by this report. Further, those subcontractors, due payment pursuant to the terms of their subcontracts will be paid within ten days after receipt of payment from WMATA.

By: _____ Title: _____ Date: _____

Washington Metropolitan Area Transit Authority

DISADVANTAGED BUSINESS ENTERPRISE (DBE)
MONTHLY PROMPT PAYMENT REPORT

SUBCONTRACTOR'S REPORT

This report is required to be submitted to the Office of Procurement, DBE Branch 600 5th Street, NW, Suite 3C, Washington, DC 20001, pursuant to the requirements of WMATA's DBE Program Plan and §26.29 of 49 CFR Part 26.

Contract No.: _____ Reporting Period: _____

Name of Subcontractor: _____ DBE – Yes or No

Subcontractor Contract Amount: _____ Total Received this Reporting Period: _____ Total Received to Date: _____

Name of Sub-Contractor	DBE (Y/N)	Description of Work	Date of Contract Awarded	Amount of Sub-Contractor Award	Amount Paid This Reporting Period	Cumulative Paid To Sub-Contractor	% of Physical Work Complete
TOTAL							

I certify the information furnished with respect to DBE subcontractor performance correct to the best of my knowledge and represents a current status for the designated period covered by this report. Further, those contractors, due payment pursuant to the terms of their subcontracts will be paid within ten days after receipt of payment from the Contractor.

By: _____ Title: _____ Date: _____

THIS PAGE NOT USED